

imageFORMULA

Document Scanner

DR-2010C

DR-2510C

User Manual

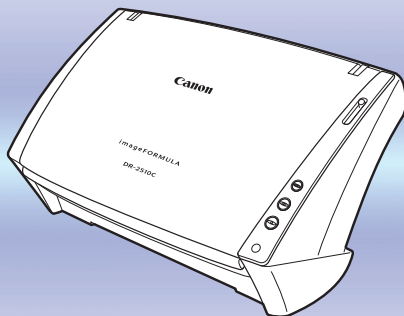

- ◆ Please read this manual before operating this scanner.
- ◆ After you finish reading this manual, store it in a safe place for future reference.

Introduction

Contents

Chapter 1 Before Using the Scanner

Chapter 2 Setup

Chapter 3 Basic Operation

Chapter 4 ISIS/TWAIN Driver Settings

Chapter 5 Job Registration Tool Settings

Chapter 6 Maintenance

Chapter 7 Troubleshooting

Chapter 8 Appendix

INDEX

International ENERGY STAR® Office Equipment Program

As an ENERGY STAR® Partner, Canon Electronics Inc. has determined that this machine meets the ENERGY STAR® Program guidelines for energy efficiency.



The International ENERGY STAR® Office Equipment Program is an international program that promotes energy saving through the use of computers and other office equipment.

The program backs the development and dissemination of products with functions that effectively reduce energy consumption. It is an open system in which business proprietors can participate voluntarily. The targeted products are office equipment, such as computers, monitors, printers, fax, machine, copiers, and scanners. The standards and logos are uniform among participating nations.

Trademarks

- Canon and the Canon logo are registered trademarks of Canon Inc. in the United States and may also be trademarks or registered trademarks in other countries.
- Microsoft and Windows are registered trademarks of Microsoft Corporation in the United States and other countries.
- ISIS is a trademark of Captiva Software Corporation, in the United States.
- Intel and Pentium are registered trademarks of Intel Corporation.
- ENERGY STAR® is a U.S. registered mark.
- Adobe is the registered trademark of Adobe Systems Incorporated in the United States and/or other countries.
- Other product and company names herein may be the trademarks of their respective owners.

Copyright

Copyright 2007 by CANON ELECTRONICS INC. All rights reserved.

No part of this publication may be reproduced or transmitted in any form or by any means, electronic or mechanical, including photocopying and recording, or by any information storage or retrieval system without the prior written permission of CANON ELECTRONICS INC.

Disclaimers

The information in this document is subject to change without notice.

CANON ELECTRONICS INC. MAKES NO WARRANTY OF ANY KIND WITH REGARD TO THIS MATERIAL, EITHER EXPRESS OR IMPLIED, EXCEPT AS PROVIDED HEREIN, INCLUDING WITHOUT LIMITATION, THERE OF, WARRANTIES AS TO MARKETABILITY, MERCHANTABILITY, FITNESS FOR A PARTICULAR PURPOSE OF USE OR NON-INFRINGEMENT. CANON ELECTRONICS INC. SHALL NOT BE LIABLE FOR ANY DIRECT, INCIDENTAL, OR CONSEQUENTIAL DAMAGES OF ANY NATURE, OR LOSSES OR EXPENSES RESULTING FROM THE USE OF THIS MATERIAL.

INTRODUCTION

Thank you for purchasing the Canon DR-2010C/DR-2510C Document Scanner. Please read this manual thoroughly before using the scanner to familiarize yourself with its capabilities, and to make the most of its many functions. After reading this manual, store it in a safe place for future reference.

Symbols Used in This Manual

The following symbols are used in this manual to explain procedures, restrictions, handling precautions, and instructions that should be observed for safety.

(See p. 12)

Indicates the number of a reference page that contains related information.

WARNING

Indicates a warning concerning operations that may lead to death or injury to persons if not performed correctly. To use the machine safely, always pay attention to these warnings.

CAUTION

Indicates a caution concerning operations that may lead to injury to persons, or damage to property if not performed correctly. To use the machine safely, always pay attention to these cautions.

IMPORTANT

Indicates operational requirements and restrictions. Be sure to read these items carefully to operate the machine correctly, and avoid damage to the machine.

NOTE

Indicates a clarification of an operation, or contains additional explanations for a procedure. Reading these notes is highly recommended.

CONTENTS

Introduction	3
Symbols Used in This Manual	3
Chapter 1 Before Using the Scanner	5
1. Important Safety Instructions	5
Installation Location	5
AC Adapter	6
Moving the Scanner	6
Handling	7
Disposal	8
2. Features of the DR-2010C/DR-2510C Document Scanner	8
3. Names and Functions of Parts	10
Chapter 2 Setup	11
1. Scanner System Requirements	11
2. Installing the Software	12
Setup Disc	12
Software Installation	13
Connecting the Scanner to the Computer	15
3. Turning the Power ON	16
Scanner Recognition	16
Chapter 3 Basic Operation	18
1. Documents	18
2. Preparing the Scanner	20
Preparing the Document Feed Tray	20
Preparing the Document Eject Tray	20
Preparing the Document Stopper	20
3. Placing Documents	21
Feeding in the Page Separation Mode	21
Feeding in the Bypass Mode	23
Placing Cards	23
Placing Folded Documents	24
4. Scanning Methods	25
Scanning With CapturePerfect 3.0	25
Scanning with the Job Function	27
Using the Scan Panel	28
Special Scanning	29
Enhancing the Text of a Document	29

Scanning Documents That Include Both Color and Black-and-White Pages	29	Feeding Options.....	52
Scanning Different Sized Documents Together.....	30	Prescan	53
Skipping Blank Pages	30	Registering Scanning Conditions	54
Scanning (Single-Sided) 11" X 17"/A3 Documents	30	Checking the Version.....	54
Deskewing Documents.....	31	Chapter 5 Job Registration Tool Settings	55
Moire Reduction.....	31	1. Starting the Job Registration Tool	55
Correcting the Text Orientation of Documents.....	31	2. Job Registration Tool Settings Dialog Box.....	56
Reducing Bleed Through for Thin Documents and Documents with Dark Reverse Sides	31	Job Registration Tool Dialog Box.....	56
Deleting Borders and Ruled Lines of a Specified Color (Red/Green/Blue)	31	New/Editing Dialog Box	56
Enhancing the Red color for Black-and-White Scanning	31	Admin Dialog Box.....	60
Creating Smaller Files.....	32	Chapter 6 Maintenance	62
Saving the Text Data of Documents as Search Keywords.....	32	1. Regular Maintenance	62
Specifying Security Settings for PDF Files.....	32	Cleaning the Scanner.....	62
5. Practical Examples.....	32	Cleaning the Inside of the Scanner	62
6. Clearing a Paper Jam.....	33	Cleaning the Sensor Glass and the Rollers	63
7. Other Functions	35	2. Removing and Attaching the Rollers and Document Holding Guide	65
Setting the Long Document Mode.....	35	Roller Replacement Cycle.....	65
Chapter 4 ISIS/TWAIN Driver Settings	37	Removing/Attaching the Feeding Roller.....	65
1. Before Using the Scanner	37	Removing/Attaching the Retard Roller	67
2. ISIS/TWAIN Driver Properties Dialog Box.....	38	Removing/Attaching the Document Holding Guide.....	69
Scan Mode Settings	39	Resetting the Counter	70
Auto Color Detection	40	Chapter 7 Troubleshooting	72
Paper Size Settings.....	41	1. Troubleshooting.....	72
Scan Resolution Settings	42	2. Uninstalling Software.....	75
Scanning Side Settings.....	42	Uninstalling the ISIS/TWAIN Driver and Job Registration Tool.....	75
Correcting Image Skewing	43	Uninstalling CapturePerfect 3.0.....	76
Moire Reduction.....	44	Chapter 8 Appendix.....	77
Adjusting the Scan Area	44	Specifications.....	77
Brightness/Contrast Adjustment.....	46	Replacement Parts	78
Gamma Curve Settings.....	47	External Dimensions.....	79
Image Contour Adjustment.....	48	INDEX	81
Image Rotation	48		
Correcting Text Orientation.....	49		
Removing the Document Background/Preventing Bleed Through.....	49		
Omitting a Specific Color.....	50		
Enhancing the Red Color.....	50		
Rapid System Recovery	51		
Double Feed Detection.....	51		

Chapter 1 Before Using the Scanner

1. Important Safety Instructions	5
Installation Location	5
AC Adapter	6
Moving the Scanner	6
Handling	7
Disposal	8
2. Features of the DR-2010C/DR-2510C Document Scanner	8
3. Names and Functions of Parts	10

1. Important Safety Instructions

To ensure the safe operation of this scanner, be sure to read the safety warnings and precautions described below.

Installation Location

The performance of this scanner is affected by the environment in which it is installed. Make sure that the location where the scanner is installed meets the following environmental requirements.

- Provide adequate space around the scanner for operation, maintenance, and ventilation.

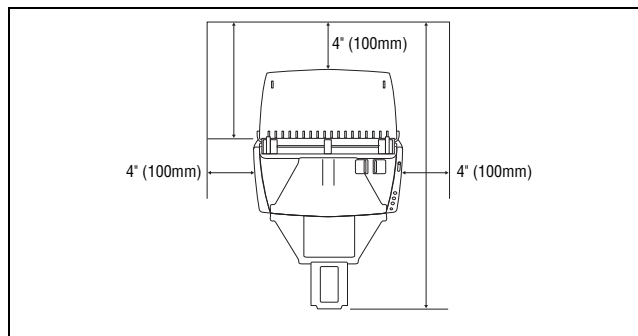

- Provide adequate space in front of the scanner for documents output after being scanned.
- Avoid installing the machine in direct sunlight. If this is unavoidable, use curtains to shade the scanner.
- Avoid locations where a considerable amount of dust accumulates.
- Avoid warm or humid locations, such as in the vicinity of a water faucet, water heater, or humidifier.
- Avoid locations where ammonia gas is emitted.
- Avoid locations near volatile or flammable materials, such as alcohol or paint thinner.
- Avoid locations that are subject to vibration.

- Avoid exposing the scanner to rapid changes in temperature. If the room in which the scanner is installed is cold but rapidly heated, water droplets (condensation) may form inside the scanner. This may result in a noticeable degradation in scanning quality.
- The following conditions are recommended for optimal scanning quality:
 - Room temperature: 10 °C to 32.5 °C (50 °F to 90.5 °F)
 - Humidity: 20% to 80% RH
- Avoid installing the scanner near equipment that generates a magnetic field (e.g. speakers, televisions, or radios.)

AC Adapter

- Connect only to a power outlet of the rated voltage and power supply frequency (120 V, 60 Hz or 220-240 V, 50/60 Hz depending on your region).
- Do not connect other electrical equipment to the same power outlet to which the scanner is connected. Also, when using an extension cord, make sure that the extension cord is rated for the current requirements of the scanner.
- Never disassemble or modify the AC adapter, as it is dangerous.
- The power cord may become damaged if it is often stepped on or if heavy objects are placed on it. Continued use of a damaged power cord and AC adapter can lead to an accident, such as a fire or electrical shock.
- Do not use the power cord while it is coiled.
- Do not pull directly on the power cord. When disconnecting the power cord, grasp the plug and remove it from the outlet.
- Keep the area around the power cord clear of objects so that the power cord can be disconnected easily in an emergency.
- Do not use an AC adapter other than the one provided with the scanner. Do not use the AC adapter provided with the scanner with other products.
- If you have any questions regarding the power supply, contact your local authorized Canon dealer or service representative for further information.

Moving the Scanner

- When moving the scanner, always hold it with both hands to avoid dropping it. The scanner weighs approximately 5.3 lb (2.4 kg).
- Make sure to disconnect the interface cable and AC adapter before moving the scanner. If the scanner is transported with these items connected, the plugs and connectors may be damaged.

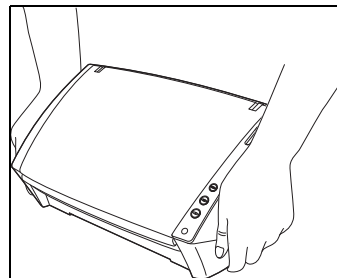

Handling

WARNING

Note the following precautions whenever using the scanner. Failure to do so may result in a fire or electric shock.

- Never use alcohol, benzene, paint thinner, aerosol sprays, or any other highly flammable substance near the scanner.
- Do not cut, damage, or modify the power cord. Do not place heavy objects on the power cord, and do not pull or excessively bend the power cord.
- Never connect the power cord when your hands are wet.
- Do not connect the scanner to a multi plug power strip.
- Do not knot or coil the power cord as this may result in a fire or electric shock. When connecting the power cord, make sure that the power plug is securely and completely inserted into the power outlet.
- Do not use a power cord or AC adapter other than the ones provided with this scanner.
- Do not take the scanner apart or modify it.
- Never try to take the AC adapter apart or modify it in any way, as this is dangerous.
- When cleaning the scanner, turn the power switch OFF and disconnect the power cord from the power supply.
- Clean the scanner using a slightly dampened cloth which has been well wrung out. Never use alcohol, benzene, paint thinner, or any other flammable substances.
- If the scanner makes strange noises, or gives off smoke, heat, or strange odors, or the scanner does not function or other abnormalities occur when you use the machine, immediately turn the power switch OFF, and disconnect the power plug from the power outlet. Then, contact your local authorized Canon dealer or service representative for further information.
- Do not drop the scanner, or subject it to impact or strong shock. Should the scanner ever become damaged, immediately turn the power switch OFF, and disconnect the power plug from the power outlet. Then, contact your local authorized Canon dealer or service representative to have the unit serviced.
- Before moving the scanner, be sure to turn the power switch OFF, and disconnect the power plug from the power outlet

CAUTION

- Do not install the scanner on a surface that is unstable or tilted, or in an area subject to excessive vibrations, as this may cause the scanner to fall, resulting in personal injury or damage to the scanner.
- Never place small metal objects such as staples, paper clips, or jewelry on the scanner. These items may fall into the scanner, and cause a fire or electric shock. Should such objects ever fall inside the scanner, immediately turn the power switch OFF, and disconnect the power plug from the power outlet. Then, contact your local authorized Canon dealer or service representative to have the unit serviced.
- Do not install the scanner in a humid or dusty location. Doing so might cause a fire or electric shock.
- Do not place objects on top of the scanner. Such objects may tip or fall over, resulting in personal injury.
- Connect only to a power outlet of the rated voltage and power supply frequency (120 V, 60 Hz or 220-240 V, 50/60 Hz depending on your region).
- When unplugging the power cord, grasp it firmly by its plug. Do not pull directly on the power cord, as this may damage or expose the cord's internal wiring, resulting in a fire or electric shock.
- Leave sufficient space around the power plug so that it can be unplugged easily. If objects are placed around the power plug, you will be unable to unplug it in an emergency.
- Do not allow water or flammable substances (alcohol, paint thinner, benzene, etc.) to spill into the scanner, as this may result in a fire or electric shock.
- Turn OFF the power switch for safety when not using the scanner for a long period of time, such as overnight. Also, turn OFF the power switch, and disconnect the power cord from the power outlet for safety when the machine will not be used for an extended period of time, such as during consecutive holidays.
- Do not wear loose clothing or jewelry that may get caught in the scanner while you are using it. This may result in personal injury. Be extra careful of neckties and long hair. If anything becomes caught in the scanner, immediately disconnect the power cord to stop the scanner.
- Be careful when loading paper into the scanner and when removing jammed paper. It is possible to cut your hand on the edge of a sheet of paper.

Disposal

- When disposing of this scanner, be sure to follow all local ordinances and laws or consult with the retailer who sold you the scanner.

2. Features of the DR-2010C/DR-2510C Document Scanner

The main features of the DR-2010C/DR-2510C document scanner are described below.

■ Compact Size

The dimensions of the scanner are as follows: 11.7" (298 mm)(W) x 9.8" (245 mm)(H) x 19.5" (490 mm)(D) (with the feed tray and eject tray open). (The size of the scanner with the feed tray and eject tray closed is 11.7" (298 mm)(W) x 6.3" (160 mm)(H) x 6.3" (160 mm)(D)).

■ Fast Document Feeding

The DR-2510C can scan a maximum of 25 documents per minute, and the DR-2010C can scan a maximum of 20 documents per minute in a range of sizes from business card to LTR/A4 size.

- Scanning conditions: Black and white/color, LTR/A4 portrait orientation one-sided/two-sided, 200 dpi

■ High Image Quality

The 600 dpi optical resolution sensor incorporated in the scanner enables documents to be scanned with high image quality.

■ Eject Tray

The eject tray enables scanned documents to be stacked. Open the eject tray when scanning documents that are not output smoothly. Scanned documents can be output without opening the eject tray.

■ USB Link Switch

The power of the scanner can be linked to be automatically turned ON/OFF in accordance with the power of the computer.

■ USB 2.0 Interface

The scanner supports Hi-Speed USB 2.0.

■ Color/Grayscale Support

Documents can be scanned in 24-bit color or 256-level grayscale.

■ Supports a Variety of Scanning Modes

The scanner supports the following scanning modes, depending on the document type:

- Single-sided/double-sided mode
- Page separation/bypass mode

■ Card Scan

You can scan business or ID cards.

■ Paper Size Detection

The scanner automatically detects the size of a scanned document and eliminates any unnecessary space around the edges of the image when storing the image, even when storing a document of irregular size.

■ Auto Color Detection

The scanner detects whether the scanned document is in color or black and white, and saves the image accordingly.

■ Folio Scan

You can scan folded documents. The scanner will scan both sides and combine the scanned images into a single image.

■ Deskew

The scanner straightens scanned images when it detects that the document was placed askew.

■ Ultrasonic Double Feed Detection (for the DR-2510C only)

Ultrasonic waves are used to detect pages that are fed at the same time as well as the space between pages. Scanning stops if a double feed is detected.

■ Text Enhancement Modes

The scanner is equipped with the Advanced Text Enhancement Mode, for enhancing the text of documents with dark or uneven backgrounds, and the Advanced Text Enhancement II mode, for enhancing the text when both the text and background are light.

These modes may not work, depending on the type of document.

■ Color Drop-out

The scanner is equipped with a Color Drop-out function that enables you to specify a color for the scanner to omit from the scanned image.

■ Skip Blank Page Function

The scanner is equipped with a Skip Blank Page function that enables you to scan a document without storing images of blank pages, regardless of whether each page of the document is two-sided or one-sided.

■ Prescan Function

The scanner is equipped with a Prescan function that allows you to adjust the contrast and brightness of a prescanned image and then send the adjusted image to the application software, without needing to scan the document again.

■ Job Function

The scanner includes three job buttons for automatically scanning and performing operations (up to ten operations, such as saving, printing, or mailing, can be registered) on the scanned image.

■ Auto Start

The scanner is equipped with an auto start function, which enables scanning to be automatically started when a document placed in the feeder is detected.

■ Compatible with Carbonless Duplicating Paper

The scanner is able to scan carbonless duplicating paper.

■ Sleep Mode

The scanner is designed to save energy by entering the sleep mode when it is not scanning documents.



NOTE

Some functions may not be available depending on the software you are using.

3. Names and Functions of Parts

This section describes the name and function of each part. Make sure to read this section and familiarize yourself with the parts of the scanner before using the scanner.

■ Front View/Right-Side View

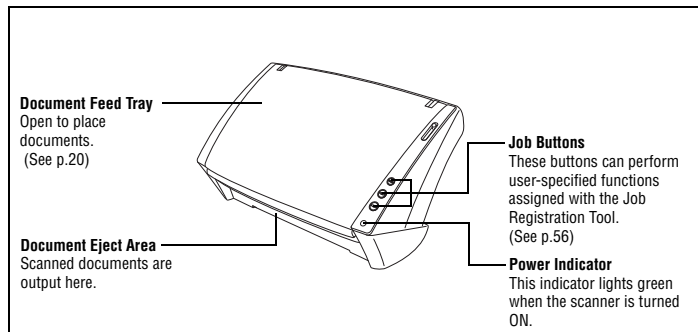

■ Front View (With the Document Feed Tray and Eject Tray Open)

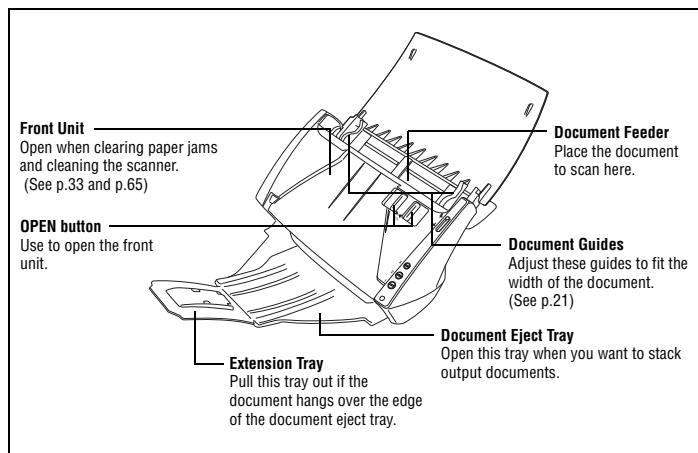

■ Back View

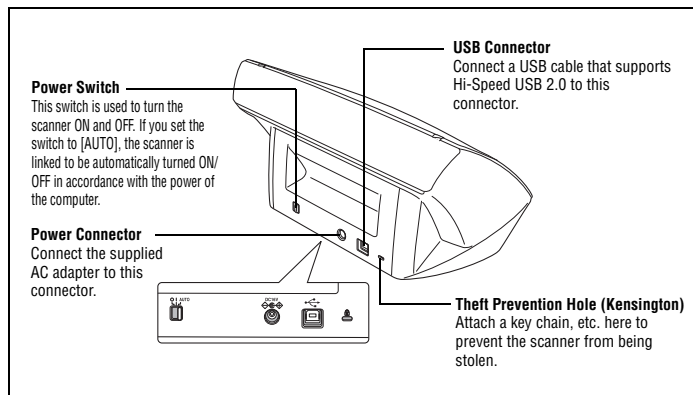

■ Feed Selection Lever

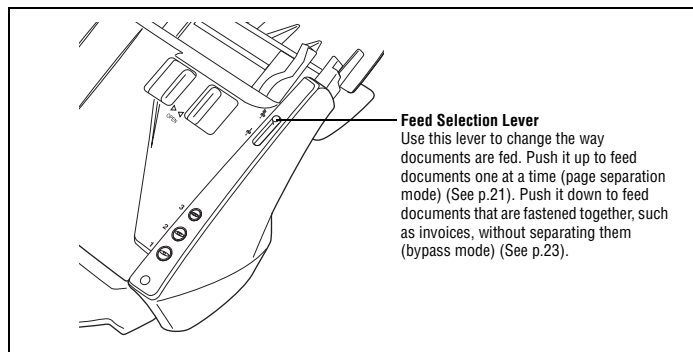

■ Paper Eject Stopper

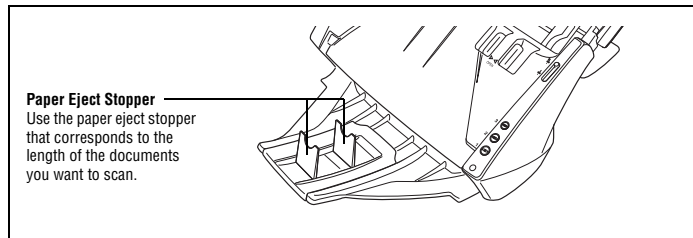

Chapter 2 Setup

1. Scanner System Requirements	11
2. Installing the Software	12
Setup Disc	12
Software Installation	13
Connecting the Scanner to the Computer	15
3. Turning the Power ON	16
Scanner Recognition	16

1. Scanner System Requirements

To use the DR-2010C/DR-2510C scanner, your computer must satisfy the following system requirements.

- One of the following operating systems:
 - Microsoft Windows 2000 Professional SP4 or later
 - Microsoft Windows XP Professional SP2 or later
 - Microsoft Windows XP Home Edition SP2 or later
 - Microsoft Windows XP Professional x64 Edition
 - Microsoft Windows Vista Home Basic
 - Microsoft Windows Vista Home Premium
 - Microsoft Windows Vista Business
 - Microsoft Windows Vista Ultimate
 - Microsoft Windows Vista Enterprise
- A computer that meets the following specifications:
 - CPU: Pentium 4 (3.2 GHz or faster)
 - Memory: 1 GB or more
 - Hard disk: 1 GB or more available space
 - CD-ROM drive
 - Hi-Speed USB 2.0
 - Monitor: Resolution of 1024 × 768 (XGA) or better recommended.
- An ISIS-compatible application or a TWAIN-compatible application that is compatible with the above operating systems.

IMPORTANT

- If you do not know the requirements for your computer system, contact the store where you purchased the computer or the manufacturer of the computer for more information.
- Use the latest USB 2.0 driver made available by Microsoft. For details, consult your local authorized Canon dealer.
- Use the USB interface provided as standard with your computer. However, normal operation is not guaranteed with all USB interfaces, even if present as standard equipment on the computer. For details, consult your local authorized Canon dealer.
- Scanning speeds are lower if your computer's standard USB interface is USB Full-Speed (equal to USB 1.1.)
- The USB cable you are using should be the one originally included with the scanner.
- If the CPU, memory, interface card, and other specifications do not satisfy the installation requirements, the scanning speed may be greatly reduced and transmission may take a long time.
- Even if the computer satisfies the recommended specifications, the scanning speed may vary, depending on the specified scan settings.
- The ISIS/TWAIN Drivers provided with the scanner do not necessarily operate on all ISIS or TWAIN-compatible applications. For details, contact your application software retailer.

2. Installing the Software

This section describes how to install the required software.

Setup Disc

The following software is included on the DR-2010C/DR-2510C Setup disc.

- DR-2010C/DR-2510C Driver
The scanner driver for using the DR-2010C/DR-2510C.
- CapturePerfect 3.0
An ISIS compatible application developed for use with Canon document scanners.



NOTE

The Setup disc of the DR-2010C/DR-2510C is configured as follows. Install the software using either [Typical Installation] or [Custom Installation].

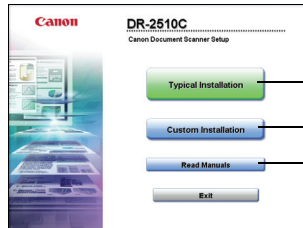

Menu Screen

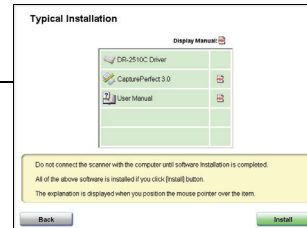

Typical Installation

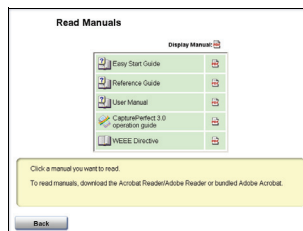

Read Manuals



Custom Installation

Software Installation

Follow the procedure below to install the software.

IMPORTANT

- Install the software before connecting the scanner to the computer.
- Log on to Windows as an Administrator.
- Close all other applications before installing the software.

- 1 Turn the power of the computer ON.
- 2 Insert the DR-2010C/DR-2510C Setup disc into the CD-ROM drive of the computer.
- 3 Click [Typical Installation].

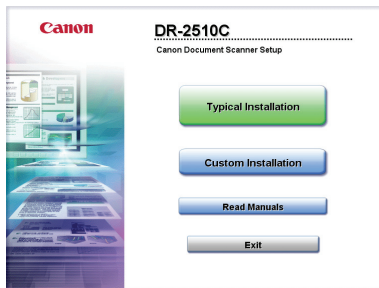

NOTE

When you select [Typical Installation], all of the displayed software and the User Manual will be installed automatically. If you want to reinstall only specific software that you have previously uninstalled, select [Custom Installation] and specify the software.

- 4 Click [Install].

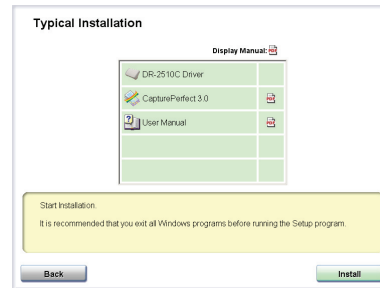

- 5 Click [Next].

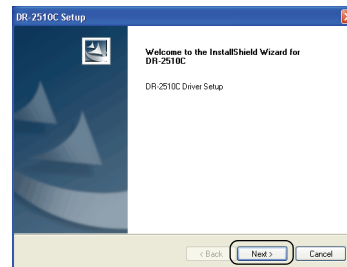

- 6 Read the license agreement → click [Yes] to accept it.

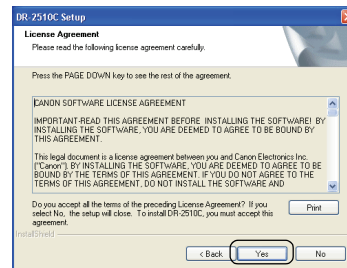

7 When the driver installation is complete, click [Finish].

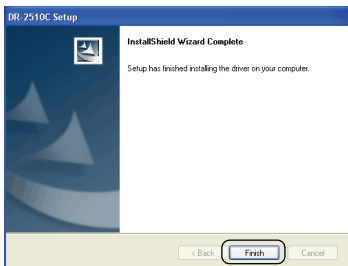

10 Confirm the installation location → click [Next].

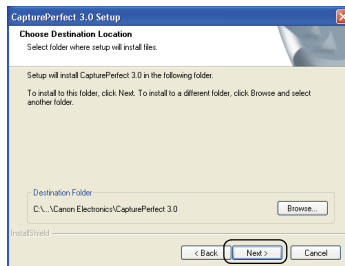

8 Click [Next].

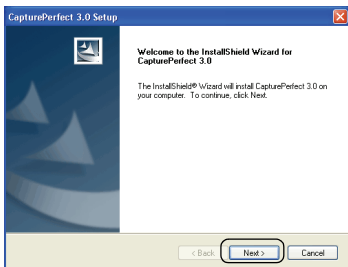

11 When the CapturePerfect 3.0 installation is complete, click [Finish].

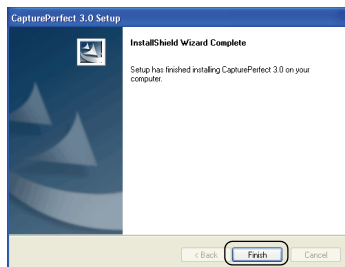

9 Read the license agreement → click [Yes] to accept it.

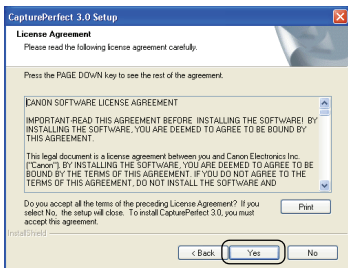

12 Click [Next].

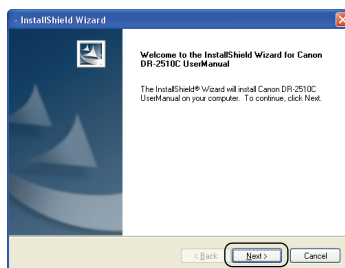

13 When the User Manual installation is complete, click [Finish].

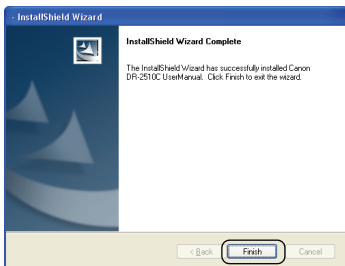

14 Click [Exit] to finish installing the software.

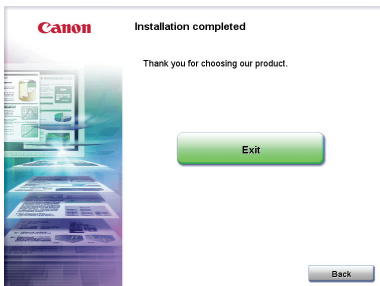

15 Remove the DR-2010C/DR-2510C Setup disc from the CD-ROM drive.

Connecting the Scanner to the Computer

Connect the scanner to the computer.



IMPORTANT

Before connecting the scanner to the computer, verify that the power switch of the scanner is OFF. If the power switch is in the ON position, push the switch to set it to OFF.

1 Verify that the power switch of the scanner is OFF (O side).

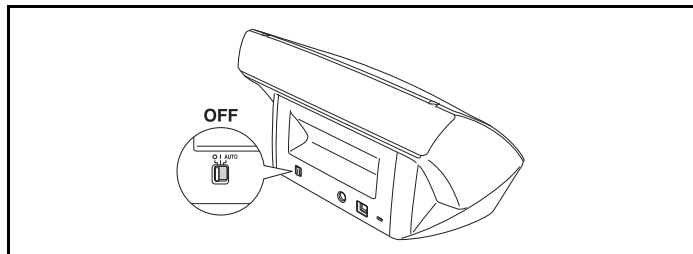

2 Connect the power cord to the AC adapter.

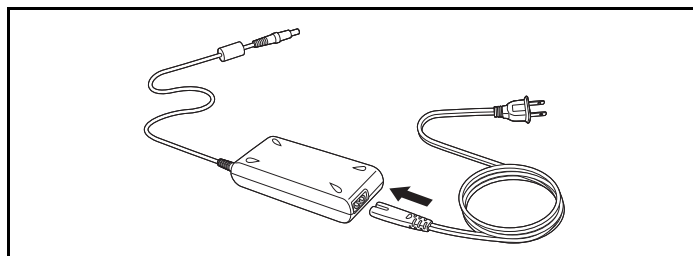

- 3** Connect the plug of the AC adapter to the power connector on the back of the scanner.

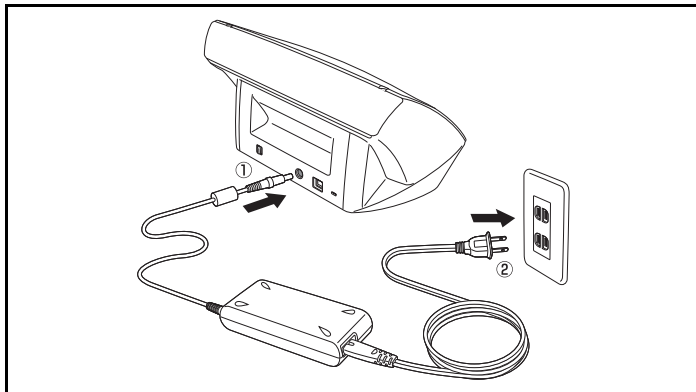

- 4** Use the supplied USB cable to connect the scanner to the computer.

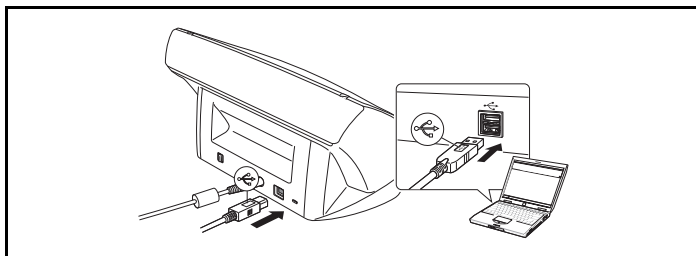

3. Turning the Power ON

When you turn the computer and the scanner ON for the first time, the Plug and Play function of Windows recognizes the scanner and automatically installs the required device driver.



IMPORTANT

- If you turn the power OFF, wait at least 10 seconds before turning it ON again.
- If you will not be using the scanner for an extended period, you should disconnect the power cord from the AC outlet for safety.

Scanner Recognition

The scanner will be recognized the first time it is connected to the computer.

- 1 Make sure that the scanner and computer are connected properly.
- 2 Press the power switch on the back of the scanner to turn the scanner ON (I side).

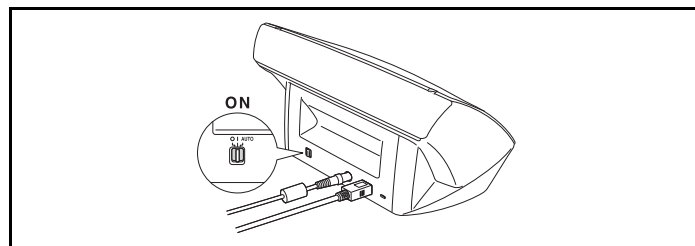

- 3 Windows automatically recognizes the DR-2010C/DR-2510C as new hardware.



NOTE

If you set the power switch on the back of the scanner to [AUTO], the scanner is linked to be automatically turned ON/OFF in accordance with the power of the computer.

Chapter 3 Basic Operation

1. Documents	18
2. Preparing the Scanner	20
Preparing the Document Feed Tray	20
Preparing the Document Eject Tray	20
Preparing the Document Stopper	20
3. Placing Documents	21
Feeding in the Page Separation Mode	21
Feeding in the Bypass Mode	23
Placing Cards	23
Placing Folded Documents	24
4. Scanning Methods	25
Scanning With CapturePerfect 3.0	25
Scanning with the Job Function	27
Using the Scan Panel	28
Special Scanning	29
5. Practical Examples	32
6. Clearing a Paper Jam	33
7. Other Functions	35
Setting the Long Document Mode	35

1. Documents

The scanner can scan documents ranging in size from business cards and checks to LTR/A4. The document sizes that this scanner can scan are shown below.

Plain Paper

Size

Width: 1.97" to 8.5" (50 mm to 216 mm)

Length: 2.12" to 14.02" (53.9 mm to 356mm)*

Paper weight: (Page separation mode)

14 to 32 lb bond (52 to 128 g/m²) 0.0024" to 0.0059" (0.06 mm to 0.15 mm)

Paper weight: (Bypass mode)

11 to 42 lb bond (40 to 157 g/m²) 0.002" to 0.0079" (0.05 mm to 0.20 mm)

* You can scan documents up to 39.2" (1000 mm) long by setting the scanner to the Long Document mode. (See "Setting the Long Document Mode," on p. 35.)



IMPORTANT

A document must meet the following criteria to be scannable:

- When scanning multiple documents of different sizes, place the documents so that they cover the entire span of the feed rollers.
- It is recommended that documents exceeding LTR, 11.69" (A4, 297 mm) size are fed one sheet at a time.
- Scanning documents before the ink is dry can cause problems with the scanner. Always make sure that the ink on a document is dry before scanning it.
- Scanning documents that are written in pencil or similar material may make the rollers and scanning glass dirty, which can lead to smudges on the scanned image and transfer the dirt to subsequent documents. Always clean the internal parts of the scanner after scanning such documents.
- When scanning a two-sided document that is printed on thin paper, the image on the opposite side of each page may show through. In this case, adjust the scanning intensity in the application software before scanning the document.
- It is recommended that thin documents are fed one sheet at a time.
- Scanning the following types of documents can cause a paper jam or malfunction. To scan such a document, make a photocopy of the document and then scan the photocopy.



Wrinkled or creased documents



Carbon paper



Curled documents



Coated paper



Torn documents



Extremely thin, translucent paper



Documents with paper clips or staples



Documents with square holes punched

Business Card

Size: 1.97" x 2.12" (50 mm x 53.9 mm) or larger
 Paper weight: 140 lb bond (300g/m²) 0.0138" (0.35 mm) or less



IMPORTANT

If a stack of business cards cannot be fed properly, reduce the number of cards in the stack.

Card

Size: 2.12" x 3.37" (53.9 mm x 85.5 mm) (ISO/JIS standard)
 Card thickness: 0.03" (0.76 mm) or less
 Orientation: horizontal feeding only
 Embossed cards can be scanned.



CAUTION

- If you place cards to be fed vertically, they may not be ejected properly, and cards that get jammed may be damaged when you remove them. Take care of the orientation when placing cards.
- Embossed cards may not be able to be scanned correctly, depending on the type of embossment.

2. Preparing the Scanner

Prepare the document feed tray according to the paper size and type.

Preparing the Document Feed Tray

Open the document feed tray.

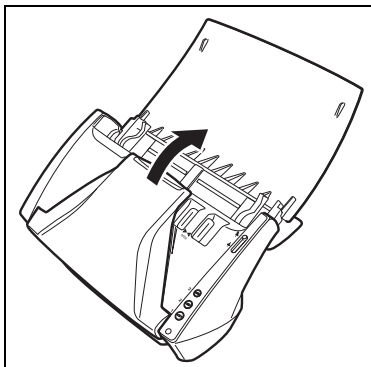

Preparing the Document Eject Tray

Open the document eject tray.

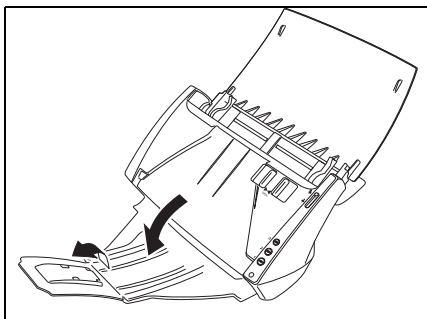

NOTE

- Documents can be scanned with the document eject tray closed.
- Open the document eject tray when you want to stack output documents.
- Use the extension tray when the document hangs over the edge of the main tray.

Preparing the Document Stopper

Use the document stopper that corresponds with the length of the document you want to scan.

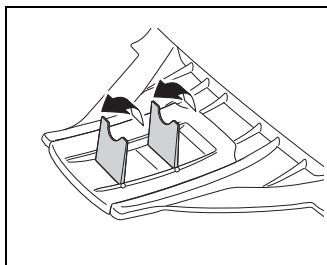

3. Placing Documents

There are two methods for feeding documents, the Page Separation mode and Bypass mode. Feeding pages continuously from a stack of documents placed in the feed tray is called the Page Separation mode. Feeding documents one sheet at a time or feeding documents consisting of multiple pages that are attached, is called the bypass mode.

The document feed method can be changed by moving the feed selection lever.

Feeding in the Page Separation Mode

- 1 Switch the feed selection lever to  (Page Separation).

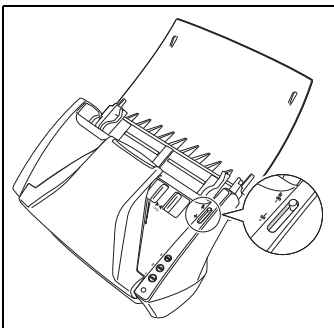

- 2 Adjust the document guides to fit the width of the document to be scanned.

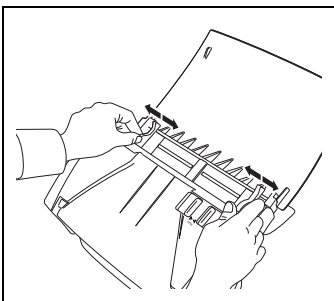

- 3 Fan the pages of the document to be scanned, and shift them so that the top of the first page (the bottom of the front of the document) is the lowest. (Place the document so that the top of the document is facing down.)

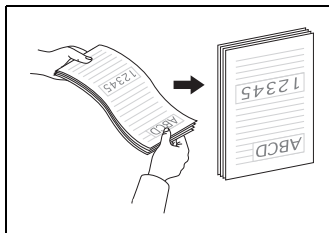

CAUTION

When placing documents into the feed tray, take care not to cut your hands on the edges of the paper.

- 4 Place the document with the reverse side facing you, and the top of the document facing down.

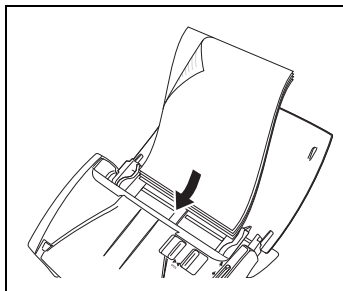

IMPORTANT

There is a load limit mark () on the document guides. Do not stack documents higher than this mark (approximately 50 sheets of 20 lb bond (80 g/m²) paper.) Doing so may cause a paper jam.

5 Adjust the document guides to fit the width of the document.

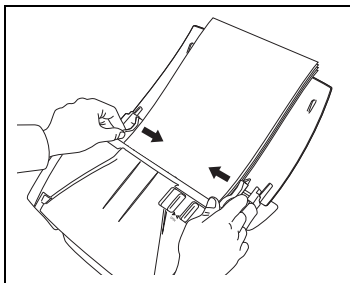

 **NOTE**

Before scanning, make sure that the document is not curled or creased, and that it is placed in the feed tray correctly. Scanning an improperly placed, curled, or creased document may damage the document or cause a paper jam.

6 Use the application software to start scanning.

 **IMPORTANT**

- Before you place a document, check to make sure it does not contain paper clips, staples, or other small metal objects. These items may cause a fire or electrical shock, damage the document, or cause a paper jam or scanner malfunction.
- Do not wear loose clothing or jewelry that may get caught in the scanner while you are using it. This may result in personal injury. Be extra careful of neckties and long hair. If anything gets caught in the scanner, immediately turn OFF the power switch, and disconnect the power cord from the power outlet to stop scanning.
- Always smooth out any folds or curls in your documents before placing them into the feeder. If the leading edge of a document is curled, it may cause a paper jam.
- If feeding stops due to a system error or paper jam while the scanner is scanning, resolve the problem, make sure that the scanned image of the last page that was successfully fed has been stored, and then resume scanning the remaining document pages.
- After you finish scanning, close the document feed tray and the document eject tray to prevent damage to the scanner while it is not being used.

Feeding in the Bypass Mode

When scanning multiple page documents that are fastened together, such as invoices, place the documents so that the edge that is fastened together is facing down.

- 1 Switch the feed selection lever to \downarrow (Bypass).

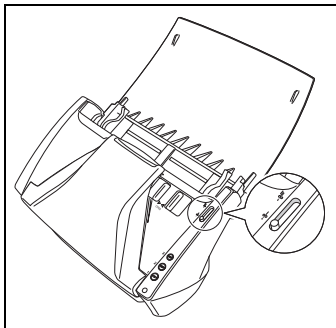

- 2 Adjust the document guides to fit the width of the document to be scanned (See p.21).

- 3 Place the document with the reverse side facing you, and the top of the document facing down (See p.21).

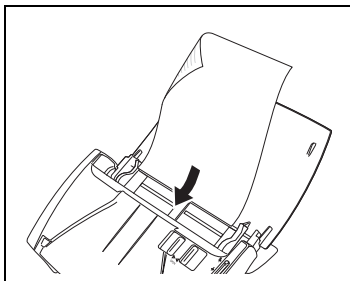

IMPORTANT

After you finish scanning, close the document feed tray and the document eject tray to prevent damage to the scanner while it is not being used.

Placing Cards

- 1 Switch the feed selection lever to \downarrow (Bypass).

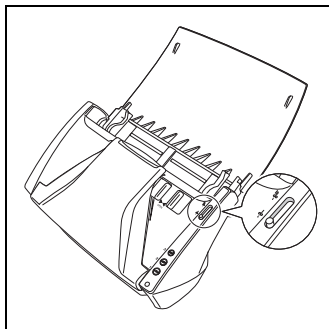

CAUTION

When scanning cards, make sure to set the feed selection lever to \downarrow (Bypass), and scan the cards one at a time.

- 2 Adjust the document guides to fit the width of the card to be scanned (See p.21).

- 3** Place the card horizontally, with the reverse side facing you, and the top of the card facing down.

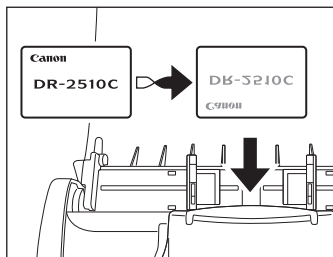

! CAUTION

If you place cards to be fed vertically, they may not be ejected properly, and cards that get jammed may be damaged when you remove them. Take care of the orientation when placing cards.

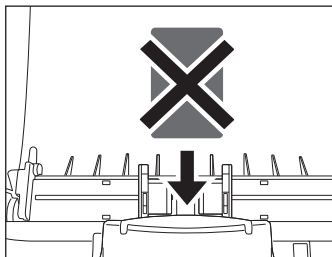

Placing Folded Documents

Folio Scan enables you to scan documents that are larger than LTR/A4 and therefore do not fit in the feeder. (The maximum size is 11" X 17"/A3.) To use the function, fold the document in half lengthwise and place it into the feeder. The DR-2010C/DR-2510C will scan both sides and combine the scanned images into a single image.

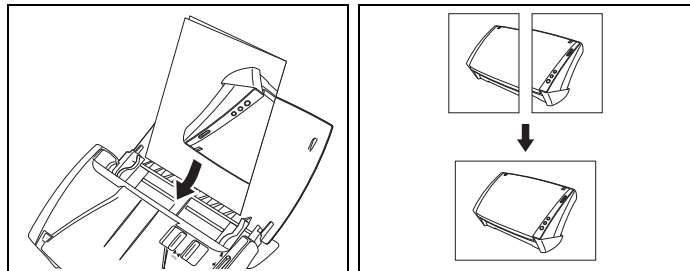

! IMPORTANT

- When folding the document, align the right and left sides and create a sharp, straight fold. Otherwise the document may jam or the image may not be aligned properly.
- The fold line itself will not be scanned. Keep this in mind if there is content such as photos, diagrams, or text that spans the fold.
- For Folio scanning, only the Bypass mode can be used. Place documents one at a time.
- Adjust the document guides to fit the width of the document. Otherwise, the image may scan as skewed or shifted.



NOTE

- When scanning folded documents, switch the feed selection lever to ♯ (Bypass).
- When placing folded documents, place the document into the scanner so that the fold is on the right side. The side of the folded document facing you will become the right side of the combined image.
- When scanning folded documents, click the [Basic] tab of the ISIS/TWAIN driver → click [Folio] in the [Scanning Side] box → click [OK]. (See Chapter 4, "ISIS/TWAIN Driver Settings.")
- The maximum size for the combined image is 11" X 17"/A3. When using the Folio function for an irregular document size, click the [Basic] tab of the ISIS/TWAIN driver → click [Auto-detection] in the [Page Size] box → click [OK].

4. Scanning Methods

When scanning with the DR-2010C/DR-2510C, in addition to scanning from an application, you can also use the Job function to perform scanning by pressing a scan button. This section describes the procedures for scanning using the CapturePerfect 3.0 software included with the scanner, scanning using the Job function, and other special scanning. For information on installing the various applications and drivers, see the *Easy Start Guide*, or Chapter 2, "Setup." For details on scan settings, see Chapter 4, "ISIS/TWAIN Driver Settings."

Scanning With CapturePerfect 3.0

This section describes how to start CapturePerfect 3.0, select the scanner, and scan documents.

The Scan Batch to File function is used here as an example.

For details, see the *CapturePerfect 3.0 Operation Guide* and CapturePerfect Online Help.

1

From the Windows task bar, click [Start] → point to [All Programs] → [CapturePerfect 3.0] → click [CapturePerfect 3.0].

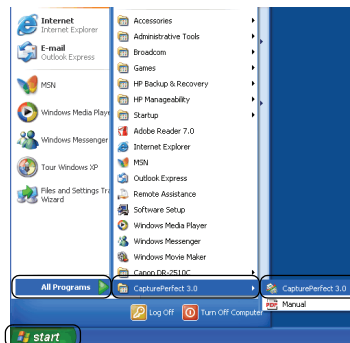

2 From the [Scan] menu, select [Select Scanner].

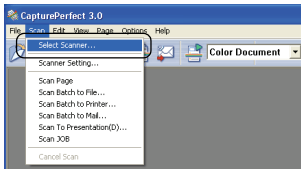

5 From the [Scan] menu, select [Scanner Setting].

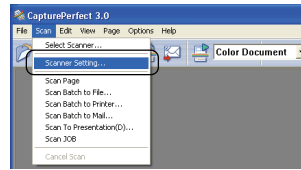

3 Select [CANON DR-2510C] or [CANON DR-2010C] → click [OK].

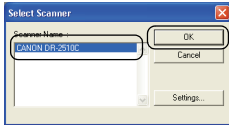

6 Set the scan settings. For more information on scan settings, see Chapter 4. "ISIS/TWAIN Driver Settings."

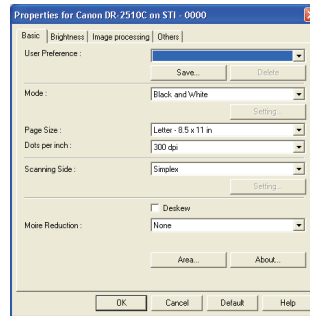

NOTE

If [Canon DR-2510C] or [Canon DR-2010C] is not displayed in the list of scanners, re-install the ISIS/TWAIN driver (See "2. Installing the Software," on p. 12.).

4 Select the default page size from the drop-down list → click [OK].

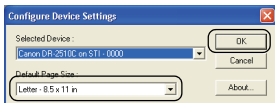

7 Place your document (See "3. Placing Documents," on p. 21.).

8 From the [Scan] menu, select [Scan Batch to File].

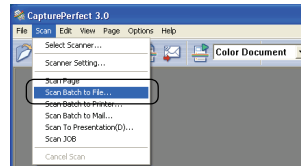

NOTE

The [Configure Device Settings] dialog box is displayed only when you select [Canon DR-2510C] or [Canon DR-2010C] for the first time and click [OK], or when you click [Setup] for [Scanner Selection].

- 9** Specify the file name and the file type for saving the image data → click [Save] to start scanning.
 * When there are no more pages of the document to scan, scanning stops, and the Continue Scanning dialog box is displayed.

- 10** Place the next document → click [Continue Scanning] to resume Scanning, or click [Stop Scanning] to end scanning.

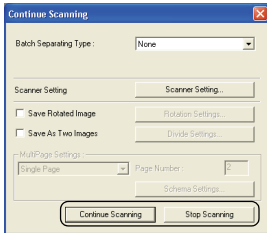

- 11** After scanning is complete, select [Exit] from the [File] menu to quit CapturePerfect 3.0.

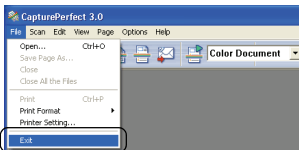

Scanning with the Job Function

This section describes how to start the Job Registration Tool and how to scan with the Job Function. For more information, see Chapter 5, "Job Registration Tool Settings."

Job Buttons

You can assign operations for performing scanning to specific job buttons (Job Function). The Job Function enables you to program the job buttons to scan documents without having to start an application on the computer. The Job Function includes functions for performing scanning, and functions for the Start and Stop button used by applications. These functions can be assigned to specific job buttons using the Job Registration Tool.



NOTE

The Job Registration Tool is a TWAIN-compliant application program that installs with the ISIS/TWAIN driver, and is used for registering the jobs that are executed when a job button is pressed.

- 1** From the Windows task bar, click [Start] → point to [All Programs] → [Canon DR-2510C] or [Canon DR-2010C] → click [Job Registration Tool].

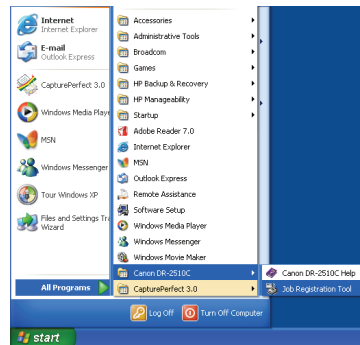

2 Register the job. For information on registering jobs, see Chapter 5, "Job Registration Tool Settings."

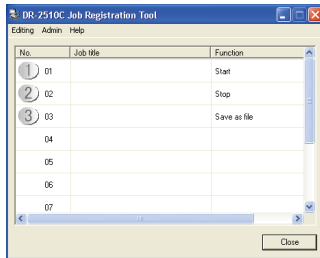

NOTE

- You can register jobs from No. 01 to No. 10.
- The following jobs are registered in the job buttons by default:
 - ① No. 01 Start: Performs scanning according to the application settings.
 - ② No. 02 Stop: Stops scanning.
 - ③ No. 03 Save File: Saves the scanned image to a specified folder in a specified format.

3 Click [Close] in the Job Registration Tool dialog box.

4 Place the document (See "3. Placing Documents," on p. 21.).

5 When you press the job button, the [Monitor for DR-2510C] or [Monitor for DR-2010C] dialog box is displayed, and scanning starts.

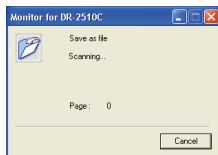

6 When scanning is complete, the image data is sent with the specified conditions.

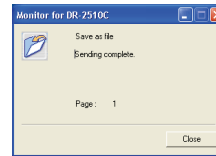

7 Click [Close] in the [Monitor for DR-2510C] or [Monitor for DR-2010C] dialog box.

Using the Scan Panel

The Scan Panel is an application that is installed with the ISIS/TWAIN driver. It is displayed in the system tray when the DR-2010C/DR-2510C driver is started. If Feeding Option in the scan settings is set to [Panel-Feeding] or [Automatic Feeding], the Scan Panel will appear when you start scanning.

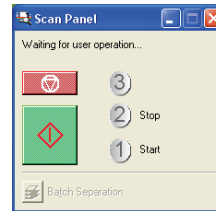

Scan Panel Functions

The Scan Panel has the following functions.

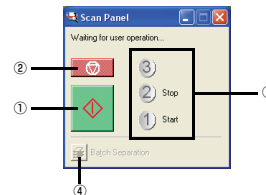

① **Start button**

If Feeding Option is set to [Panel-Feeding], clicking this button starts scanning.

② **Stop button**

Stops scanning.

③ **Job display**

When the Start and Stop functions are assigned to the job buttons, [Start] and [Stop] are shown here.

If nothing is shown on the job display, the Start and Stop functions are not assigned to the job buttons. In this case, you should use the Start and Stop buttons on the Scan Panel.

④ **Batch separation button**

After selecting [Panel] as the batch separation setting on the [Others] tab, if you enable batch separation from the application and start scanning, this button becomes active when scanning of the current document completes, and scanning stops. When clicked, this button depresses and remains depressed while scanning with batch separation continues, until scanning of the current document completes, and scanning stops. The button then returns to normal.

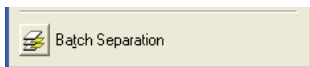

Special Scanning

This section describes examples of settings that can be specified when scanning with the DR-2010C/DR-2510C. For more information, see Chapter 4, "ISIS/TWAIN Driver Settings," or the Online Help.

Enhancing the Text of a Document

You can set the scanning conditions to enhance the text of documents with dark backgrounds or documents with a light uniform background and low-contrast text. Click the [Basic] tab in the settings dialog box, and then click [Advanced Text Enhancement] or [Advanced Text Enhancement II] in the [Mode] box. For more information on setting the scanning conditions, see Chapter 4, "ISIS/TWAIN Driver Settings - Scan Mode Settings."



Document to Scan

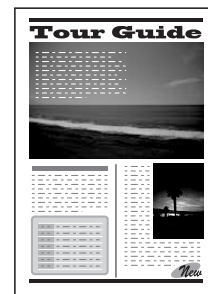

Text Enhancement

Scanning Documents That Include Both Color and Black-and-White Pages

You can set the scanning conditions to detect whether the document to scan is in color or black and white, and save it as a color image or black and white image accordingly.

Click the [Basic] tab in the settings dialog box, and then click [Auto Color Detection] in the [Mode] box.

For more information on setting the scanning conditions, see Chapter 4, "ISIS/TWAIN Driver Settings - Auto Color Detection."

Scanning Different Sized Documents Together

You can set the scanning conditions to scan different sized documents, such as LTR and LGL documents, together, while detecting the correct size of the document.

Click the [Basic] tab in the settings dialog box, and then click [Auto-detection] in the [Page Size] box.

For more information on setting the scanning conditions, see Chapter 2, "Using the Scanner - Scanning Different Sized Documents," in the *Reference Guide*.

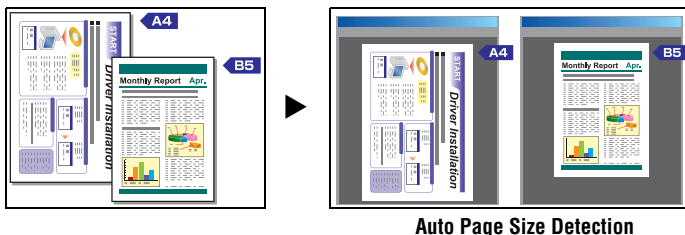

IMPORTANT

When scanning multiple documents of different sizes, place the documents so that they cover the entire span of the feed rollers.

Skipping Blank Pages

You can set the scanning conditions to determine whether a scanned image is a blank page, and skip saving the image if so.

Click the [Basic] tab in the settings dialog box, and then click [Skip Blank Page] in the [Scanning Side] box.

For more information on setting the scanning conditions, see Chapter 4, "ISIS/TWAIN Driver Settings - Scanning Side Settings."

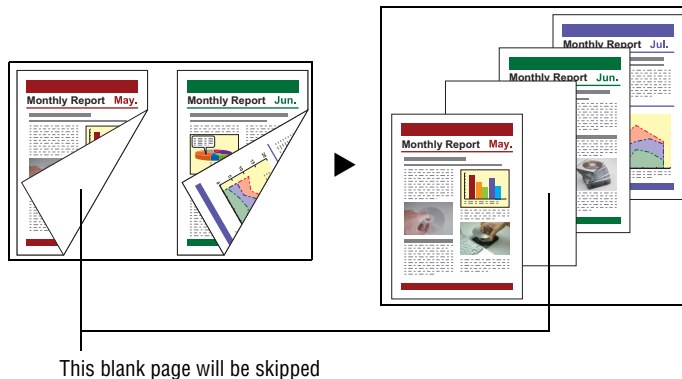

Scanning (Single-Sided) 11" X 17"/A3 Documents

You can set the scanning conditions to scan both sides of an 11" X 17"/A3 document folded in half to be combined as a single image.

Click the [Basic] tab in the settings dialog box, and then click [Folio] in the [Scanning Side] box.

For more information on setting the scanning conditions, see "Placing Folded Documents" (p. 24) and Chapter 4, "ISIS/TWAIN Driver Settings - Scanning Side Settings."

Deskewing Documents

You can set the scanning conditions to detect slanted document pages and straighten the scanned images.

Click the [Basic] tab in the settings dialog box, and then select the [Deskew] check box.

For more information on setting the scanning conditions, see Chapter 4, "ISIS/TWAIN Driver Settings - Correcting Image Skewing."

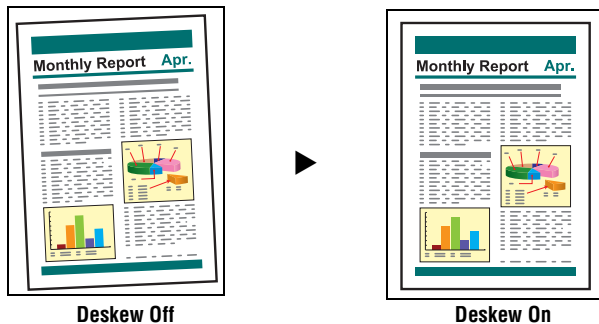

Moire Reduction

You can set the scanning conditions to reduce the moire effect (a shimmering, wavy pattern) that often appears when scanning color documents or scanning in grayscale.

Click the [Basic] tab in the settings dialog box, and then click [High Quality Moire Reduction] in the [Moire Reduction] box.

For more information on setting the scanning conditions, see Chapter 4, "ISIS/TWAIN Driver Settings - Moire Reduction."

Correcting the Text Orientation of Documents

You can set the scanning conditions to detect the text orientation in scanned images, and rotate the images in 90° increments as needed to normalize the orientation.

Click the [Image processing] tab in the settings dialog box, and then select the [Text Orientation Detection] check box.

For more information on setting the scanning conditions, see Chapter 4, "ISIS/TWAIN Driver Settings - Correcting Text Orientation."

Reducing Bleed Through for Thin Documents and Documents with Dark Reverse Sides

You can set the scanning conditions to reduce bleed through when scanning thin document pages and those with dark content on the back side, or to remove the background from document images.

Click the [Image processing] tab in the settings dialog box, select the [Prevent Bleed Through / Remove Background] check box, and then click [Settings].

For more information on setting the scanning conditions, see Chapter 4, "ISIS/TWAIN Driver Settings - Removing the Document Background/Bleeding."

Deleting Borders and Ruled Lines of a Specified Color (Red/Green/Blue)

You can set the scanning conditions to omit borders and ruled lines of a specified color (red, green, or blue) from the scanned image. However, this function is only available when scanning in black-and-white.

Click the [Image processing] tab in the settings dialog box, and then click the color to omit in the [Color drop-out] box.

For more information on setting the scanning conditions, see Chapter 4, "ISIS/TWAIN Driver Settings - Omitting a Specific Color."

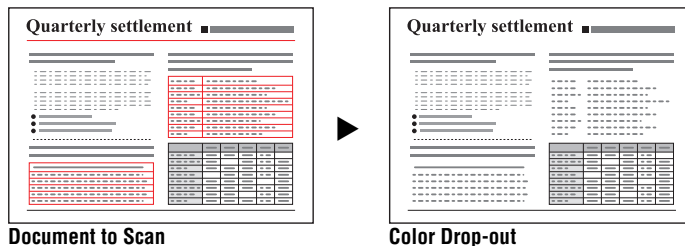

Enhancing the Red color for Black-and-White Scanning

You can set the scanning conditions to enhance the red color when performing black and white scanning.

Click the [Image processing] tab in the settings dialog box, and then click [Red Enhance] in the [Color drop-out] box.

For more information on setting the scanning conditions, see Chapter 4, "ISIS/TWAIN Driver Settings - Enhancing the Red Color."

Creating Smaller Files

You can set the scanning conditions to save the scanned image as a PDF file with a high compression rate, so that the file size is smaller.

Click [PDF File] in the [Options] menu of CapturePerfect 3.0, and then click [High compression] in [Mode].

For more information on setting the scanning conditions, see the *CapturePerfect3.0 Operation Guide*.

Saving the Text Data of Documents as Search Keywords

You can set the scanning conditions to convert the text information of a document into text data when creating a PDF file, to be used when searching the text on a computer.

Click [OCR Settings] in the [Options] menu of CapturePerfect 3.0, and then select the [Enable] check box, and choose the language to apply OCR.

For more information on setting the scanning conditions, see the *CapturePerfect3.0 Operation Guide*.

Specifying Security Settings for PDF Files

You can specify security settings to restrict the viewing, printing, and editing of PDF files created with CapturePerfect 3.0.

For more information on specifying security settings, see the *CapturePerfect3.0 Operation Guide*.

5. Practical Examples

This section provides examples of settings when scanning with the DR-2010C/DR-2510C. Refer to these examples when specifying ISIS/TWAIN driver settings. For descriptions of particular setting items, see "Chapter 4 ISIS/TWAIN Driver Settings," on p. 37.

Scanning Both Sides of Pages

- **To scan both sides of pages**
Select [Duplex] for the Scanning Side setting.

Scanning Non-Standard Size Documents

- **To scan irregular size documents**
If irregular size documents are scanned with a standard size selected for the Page Size setting, black areas may appear around the scanned document image. To scan irregular size documents, select [Auto-detection] as the [Page Size]. The page size is then detected automatically.
- **To register an irregular page size for scanning documents**
An irregular document size not already registered as a page size selection can be saved as a custom page size.
(See "Adjusting the Scan Area," on p. 44.)
- **To scan only part of the document page**
You can specify the scanning area. However, you cannot set the scan area when [Auto-detection] is selected for [Page Size].
(See "Adjusting the Scan Area," on p. 44.)

Scanning Multiple Batches as One Document

- **To scan a document that has too many pages to be loaded all at once as separate batches**
Click [Automatic Feeding] in the [Feeding Option] box. When this option is selected, the scanner detects documents and starts scanning as they are loaded, so continuous scanning is possible by loading the document batches repeatedly.
If you click [Panel Feeding] in the [Feeding Option] box, scanning does not start until you press the Scan button. This is useful if you want to straighten documents after you have placed them in the scanner.

- **To create separate files for each batch of documents during continuous scanning**
Click [Automatic Feeding] or [Panel Feeding] in the [Feeding Option] box, and click [Auto] in [Batch Separation]. (Only for the ISIS driver.)
- **To scan a batch of documents one page at a time**
Click [Automatic Feeding] or [Panel Feeding] in the [Feeding Option] box and scan the documents one page at a time. After each page is scanned, the [Scan Panel] dialog box is displayed. If you selected [Automatic Feeding] in the [Feeding Option] box, the scanner detects when the next document is placed and continues scanning. If you selected [Panel Feeding] in the [Feeding Option] box, press the Scan button after placing the next document to continue scanning.

Prescan

- **To confirm images before scanning**
Select the [Prescan] check box. The [Prescan] dialog box is displayed when scanning starts.
(See "Prescan," on p. 53.)

Registering Settings

- **Registering Your Settings**
Register a name for your settings in the user preferences. When you want to recall your settings later, select the name of your registered user preferences, and they will be reflected in the dialog boxes.
(See "Registering Scanning Conditions," on p. 54.)

By using the Job Function or the Job Scan function of CapturePerfect 3.0, you can register scanning conditions and methods for processing scanned image files as jobs, and scan by selecting a job.

6. Clearing a Paper Jam

When paper jams occur during scanning, use the following procedure to clear them.

! CAUTION

When removing jammed paper, take care not to cut your hands on the edges of the paper.

- 1 Remove any documents that have been left in the eject tray.

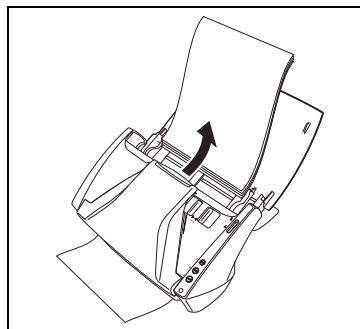

- 2 Press the OPEN knob from both sides (①), and pull the front unit out and downward to open it (②).

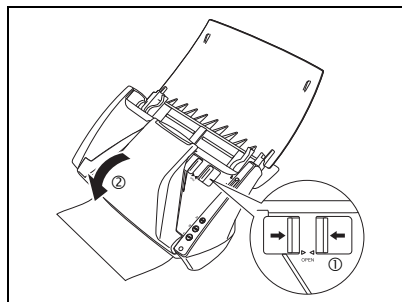

- 3** Remove the jammed document from the document feeding side or document ejecting side.

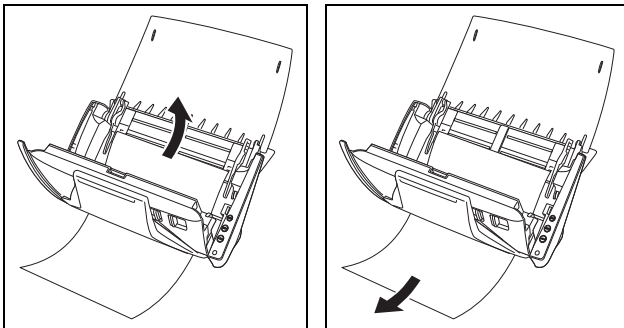

NOTE

If a paper jam occurs when [Rapid recovery system] is enabled in the [Others] tab of the ISIS/TWAIN driver settings dialog box, the image data of the document is not saved and scanning stops. This allows you to continue scanning from the document that caused the paper jam after the paper jam is fixed.



IMPORTANT

Make sure to pull the document out carefully, without applying too much force. If the jammed paper tears while you are pulling it out, make sure to remove any remaining pieces from inside the scanner.

- 4** Close the front unit by gently pushing it up on both sides until clicks into place. Make sure that the front unit is completely closed by pushing until you hear a click.

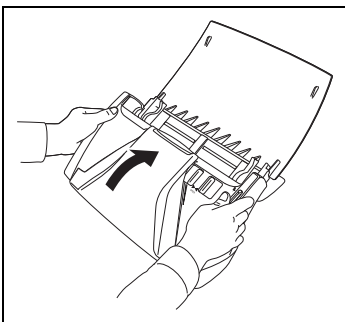

After removing the jammed paper, check to see if the last page was scanned correctly, and then continue scanning.

7. Other Functions

Setting the Long Document Mode

The length of documents that can be scanned with the DR-2010C/DR-2510C is normally 14.02" (356 mm), but you can scan documents up to 39.2" (1000 mm) long by setting the scanner to the Long Document mode.

IMPORTANT

When scanning in the Long Document mode, click the [Basic] tab of the ISIS/TWAIN driver properties dialog box and set the paper size to [Auto-detection] to allow the scanner to detect and scan documents up to 39.2" (1,000 mm) long. Note the following when using the Long Document mode:

- When scanning in the Long Document mode, if the document is placed on the scanner in a skewed position, it may hit the edges of the feeding area and be damaged. Be careful to place the document so that it is not skewed.
- When scanning with the Long Document mode, paper jam detection may react slowly, resulting in damage to the document. Be careful to avoid paper jams.
- When scanning long documents, make sure to set the feed selection lever to ϕ (Bypass), and scan the documents one at a time.

1 Click the [Start] button → [Control Panel].

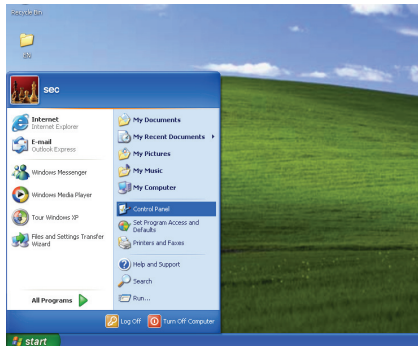

2 Double-click [Scanners and Cameras].

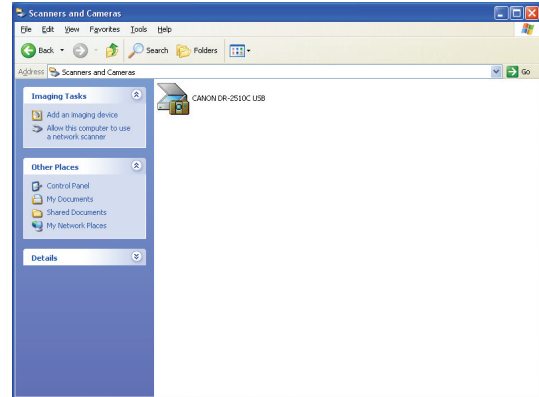

3 Right-click [CANON DR-2010C USB] or [CANON DR-2510C USB] → click [Properties].

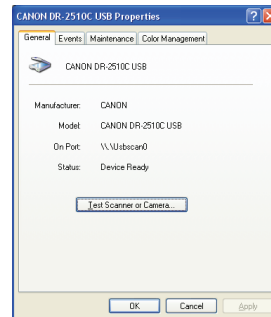

4 Click the [Maintenance] tab → [Long Document Mode (1,000 mm)].

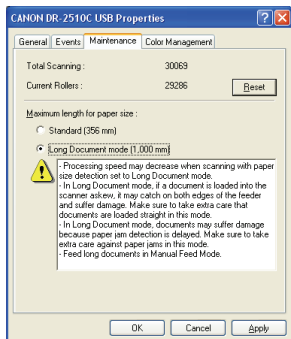

5 Click [Apply] → [OK].

6 Turn the scanner OFF and then ON again.

Chapter 4 ISIS/TWAIN Driver Settings

1. Before Using the Scanner	37
2. ISIS/TWAIN Driver Properties Dialog Box	38
Scan Mode Settings	39
Auto Color Detection	40
Paper Size Settings	41
Scan Resolution Settings	42
Scanning Side Settings	42
Correcting Image Skewing	43
Moire Reduction	44
Adjusting the Scan Area	44
Brightness/Contrast Adjustment	46
Gamma Curve Settings	47
Image Contour Adjustment	48
Image Rotation	48
Correcting Text Orientation	49
Removing the Document Background/Preventing Bleed Through	49
Omitting a Specific Color	50
Enhancing the Red Color	50
Rapid System Recovery	51
Double Feed Detection	51
Feeding Options	52
Prescan	53
Registering Scanning Conditions	54
Checking the Version	54

1. Before Using the Scanner

To use the DR-2010C/DR-2510C with an ISIS/TWAIN-compliant application, the DR-2010C/DR-2510C must first be selected as the scanner to be used. This section describes how to select the scanner using CapturePerfect 3.0.

1 From the Windows task bar, click [Start] → point to [All Programs] → [CapturePerfect 3.0] → click [CapturePerfect 3.0].

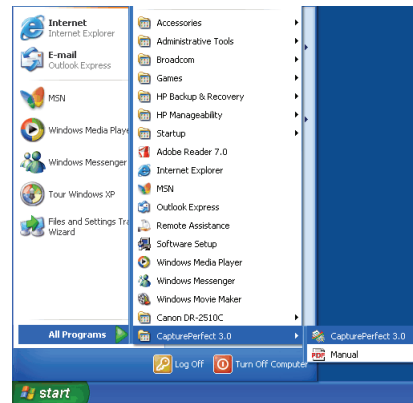

2 From the [Scan] menu, select [Select Scanner].

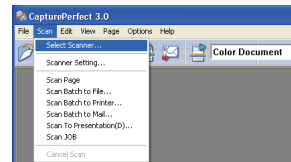

3 Select [Canon DR-2510C] or [Canon DR-2010C] → click [OK].

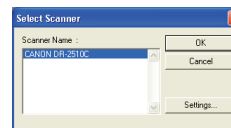

NOTE

If [Canon DR-2510C] or [Canon DR-2010C] is not displayed in the list of scanners, reinstall the ISIS/TWAIN driver. (See "Chapter 2 Setup - 2. Installing the Software," on p. 12)

4 Select the default page size from the drop-down list → click [OK].

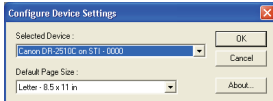

NOTE

- The [Configure Device Settings] dialog box is displayed only when you select [Canon DR-2510C] or [Canon DR-2010C] for the first time and click [OK], or when you click [Setup] for [Scanner Selection].
- The settings here are applied when you click the [Default] button on the ISIS driver properties dialog box.
- For a TWAIN driver, the default value is set to "LTR" and cannot be changed.

5 From the [Scan] menu, select [Scanner Setting].

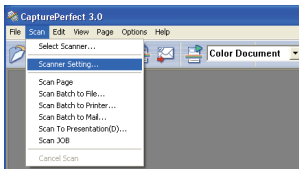

The ISIS/TWAIN driver properties dialog box is displayed.

2. ISIS/TWAIN Driver Properties Dialog Box

The ISIS/TWAIN driver properties dialog box is displayed when you select [Scanner Setting] on the [Scan] menu of CapturePerfect 3.0. It consists of four tabs: the [Basic] tab, [Brightness] tab, [Image processing] tab, and [Others] tab.

Specify the settings on each tab as necessary to set the scanning conditions. For details on each setting, also refer to the Help.

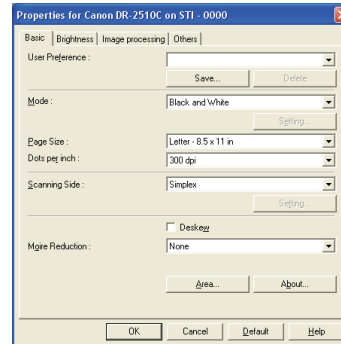

[OK] button

Confirms the settings and closes the dialog box.

[Scan] button

For a TWAIN compatible application that can perform scanning from the properties dialog box, the [Scan] button is displayed instead of the [OK] button. Press the [Scan] button to scan with the displayed settings.

[Cancel] button

Cancels the settings and closes the dialog box.

[Default] button

Returns the settings to their default values.

[Help] button

Displays Help for the currently open tab or dialog box.



NOTE

If you are using a TWAIN driver, the two extra settings below are displayed on the [Basic] tab and [Image processing] tab. Refer to the Help for details.

- [Basic] tab: Scan options
- [Image processing]: Black/white reversion

Scan Mode Settings

This section describes the procedure for setting the scan mode to suit your needs.

1

In the ISIS/TWAIN driver properties dialog box, click the [Basic] tab → select the scanning mode from the [Mode] drop-down list.

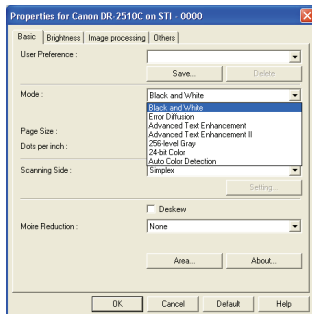

You can select the following modes, according to the type of document you want to scan. Note that some functions may be restricted, depending on the mode settings.

■ Black-and-White

- [Black and White]
Use this mode to scan text and line drawing documents as black-and-white (binary) images.
- [Error Diffusion]
Use this mode to scan documents containing photos as black-and-white (binary) images.

- [Advanced Text Enhancement]
Use this mode to scan documents with a dark or non-uniform (pattern) background.
 - If the background is uniform it is removed where it surrounds the text.
 - If the background is non-uniform, such as a pattern, it is processed to enhance text readability.
- [Advanced Text Enhancement II]
Use this mode to scan documents with a light uniform background and low-contrast text.
 - The background in tight spaces around text may not be removed.
 - Documents with low-contrast text can be made more readable by adjusting [Contrast] on the [Brightness] tab.
 - If the background is non-uniform, such as a pattern, the background remains visible in the scanned image, and text may be hard to read.

■ Grayscale

- [256-level Gray]
Scans documents containing photos as grayscale images.

■ Color

- [24-bit Color]
Scans documents containing color photos as full-color images.

■ Auto Color Detection

- [Auto Color Detection]
Whether a document is black-and-white or color is detected before the scanned image is saved.
 - When [Auto Color Detection] is enabled, the [Setting] button is enabled for opening the [Auto Color Detection] dialog box, where you can make settings affecting how color documents are scanned, and select which scanning mode to use for black-and-white.
 - Depending on the application program, operation may become unstable when [Auto Color Detection] is enabled. In that case, [Auto Color Detection] should be disabled.
 - For details, See "Auto Color Detection," on p. 40.

The following tab functions are partially disabled according to the selected mode.

Settings Tab	Basic		Image processing				Others	
	Deskew	Moire Reduction	Edge emphasis	Prevent Bleed Through / Remove Background	Black/white reversion (TWAIN driver)	Color Drop-out	Batch Separation	Prescan
Scanning Mode								
Black and White	○	○	○	○	○	○	○	○
Error Diffusion	○	○	○	○	○	○	○	○
Advanced Text Enhancement	○	○	○	—	○	○	○	○
Advanced Text Enhancement II	○	○	—	—	○	○	○	○
256-level Gray	○	○	○	○	—	○	○	○
24-bit Color	○	○	○	○	—	—	○	○
Auto Color Detection	○	○	○	—	—	—	—	—

○: Available for setting —: Not available for setting or automatically set

Auto Color Detection

This section describes the procedure for setting the scanner to automatically detect whether a document is in color or black-and-white when scanning.

- 1 In the ISIS/TWAIN driver properties dialog box, click the [Basic] tab → select [Auto Color Detection] from the [Mode] drop-down list → click [Setting].

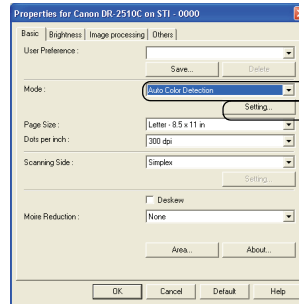

- 2 Specify the various settings in the [Auto Image Type Detection Settings] dialog box → click [OK].

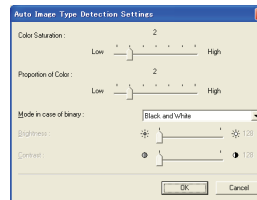

The settings you can specify are as follows.

- [Color Saturation/Proportion of Color]

Normally scan with the default values (Color Saturation: 2, Proportion of Color: 2), but change the settings when you want to scan a color document as a black-and-white document.

- Color Saturation: change the setting towards "High" when you want to scan a color document with low color saturation as a black-and-white document.
- Proportion of Color: change the setting towards "High" when you want to scan a color document with a low proportion of color as a black-and-white document.

- **[Mode in case of binary]**
Select the scanning mode when a page is detected as black and white.
- **[Brightness]**
This setting adjusts the brightness when [Advanced Text Enhancement] or [Advanced Text Enhancement II] is selected with the Black and White mode. For other modes, the brightness is set from the [Brightness] tab.
- **[Contrast]**
This setting adjusts the contrast when [Advanced Text Enhancement II] is selected with the Black and White mode. For other modes, the contrast is set from the [Brightness] tab.

Paper Size Settings

This section describes the procedure for selecting the size for scanning.

- 1 Click the [Basic] tab → click the page size in [Page Size].

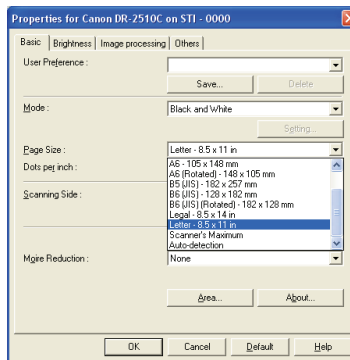

NOTE

- Click [Auto-detection] to scan the following kinds of documents.
 - Documents of undetermined size
 - Documents including mixed page sizes
 - When using the Long Document mode (See "Setting the Long Document Mode," on p. 35.)
- When [Auto-detection] is selected, the [Area] setting in the [Scan Area] dialog box is disabled.
- The [Auto-detection] process may malfunction in the following situations. If this occurs, select a standard size such as [A4] or [Letter], or click the [Area] button to create a custom page size.
 - When scanning a page with a dark area at the left or right edge
 - When scanning a glossy or reflective document
 - When the brightness setting is incorrect
 - When [Custom] is selected in the [Gamma Settings] dialog box
- Depending on the application, operation may become unstable when [Auto-detection] is enabled. In that case, [Auto-detection] should be disabled.

Scan Resolution Settings

This section describes the procedure for setting the resolution for scanning.

- 1 In the ISIS/TWAIN driver properties dialog box, click the [Basic] tab → select the resolution for scanning from the [Dots per inch] drop-down list.

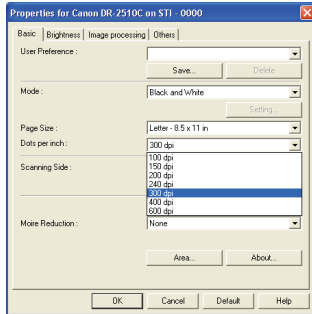

NOTE

- Higher resolutions provide clearer images, but produce larger files.
- When the selected resolution is 300 dpi or less, the [Moire Reduction] setting is automatically enabled to allow reduction of the moire effect (a shimmering, wavy pattern) in scanned images.

Scanning Side Settings

This section describes the procedure for setting the page side settings for scanning.

- 1 In the ISIS/TWAIN driver properties dialog box, click the [Basic] tab → select the page side to scan from the [Scanning Side] drop-down list.

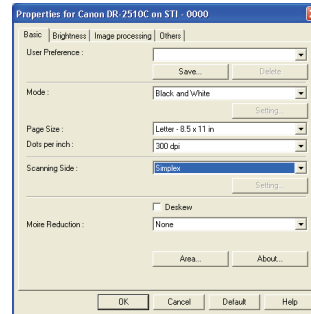

Specify one of the settings below according to the page side setting you want to use.

- **[Simplex]**
Scan only the front side of documents loaded into the feeder.
- **[Duplex]**
Scan both sides of documents.

- [Skip Blank Page]

As each document page is scanned, the scanner detects whether it is blank, and if so, the image is not saved.

- Selecting [Skip Blank Page] enables the [Setting] button, which opens the [Blank Skip Setting] dialog box.
- Adjust the [Content density] setting in the [Blank Skip Setting] dialog box if blank pages are not skipped, or if non-blank pages are skipped.

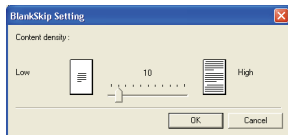

- The [Content density] setting should be adjusted according to the document content, so that only blank pages are skipped: increase the setting if they are not skipped, and decrease the setting if non-blank pages are skipped.
- The Skip Blank Pages function may not work properly if the [Custom] setting is enabled in the [Gamma Settings] dialog box.
- If a scanning side setting (simplex or duplex) is specified in the application settings, set [Simplex].

- [Folio]

Documents that are normally folded in half are scanned on both sides and composed into one image.

- You cannot click [Folio] if you click [Patchcode] in the [Batch Separation] box of the [Others] tab.

Correcting Image Skewing

This section describes the procedure for setting the scanner to detect slanted document pages and straighten the scanned images.

1

In the ISIS/TWAIN driver properties dialog box, click the [Basic] tab → select the [Deskew] check box.

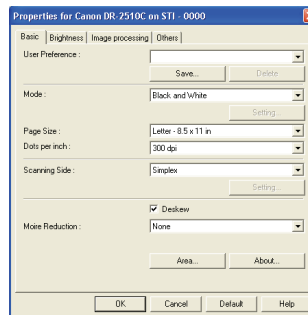

NOTE

Deskewing SWITCH also may not work properly or cause part of the image to be lost in other cases, depending on the document.

Moire Reduction

This section describes the procedure for setting to reduce the moire effect (a shimmering, wavy pattern) that may appear when scanning color documents or scanning in grayscale.

- 1 In the ISIS/TWAIN driver properties dialog box, click the [Basic] tab → select [High Quality Moire Reduction] from the [Moire Reduction] drop-down list.

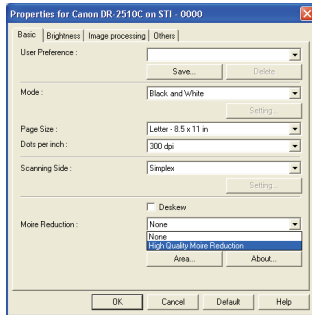

NOTE

When a resolution higher than 300 dpi is selected for [Dots per inch], [High Quality Moire Reduction] is greyed out.

- When a resolution of 240 dpi or less is selected for [Dots per inch], you can click [High Speed Moire Reduction].
- Select one of the following according to the resolution you have set:

[None]

Do not perform moire reduction.

[High Speed Moire Reduction]

This mode prioritizes speed, and generates an image of the specified resolution from an image scanned at 300 dpi.

[High Quality More Reduction]

This mode prioritizes image quality, and generates an image of the specified resolution from an image scanned at 600 dpi. The image quality is higher, but the scanning speed decreases.

Adjusting the Scan Area

This section describes the procedure for scanning part of a document image.

- 1 In the ISIS/TWAIN driver properties dialog box, click the [Basic] tab → click [Area].

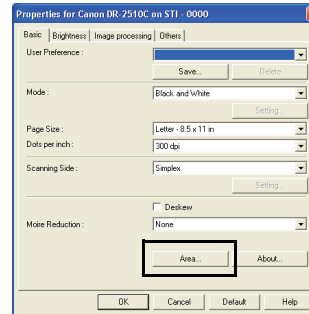

NOTE

In the [Scan Area] dialog box you can define the area of the document page to scan on a selected page size, and register non-standard document page sizes.

The [Scan Area] dialog box is different for ISIS and TWAIN drivers: for the TWAIN driver, one of two dialog box types is displayed depending on the application program used.

Scan Area Dialog Box (ISIS Driver)

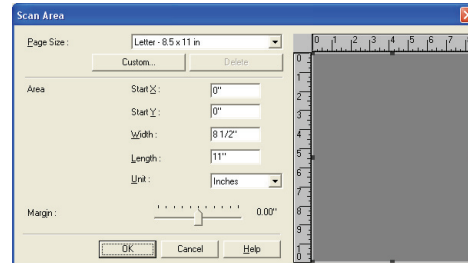

Scan Area Dialog Box (TWAIN Driver)

This dialog box appears with application programs that display the [Scan] button in the Properties dialog box.

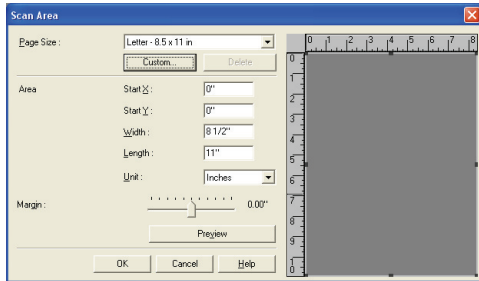

The Area window and [Preview] button are not displayed when using applications like the Job Registration Tool that display the [OK] button in the Properties dialog box.

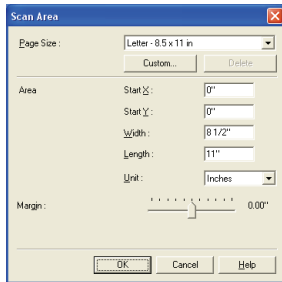

Page Size

This setting is linked to the [Page Size] setting, for selecting the size of document pages to scan. Clicking the [Custom] button opens the [Custom Page Size] dialog box, where non-standard page sizes can be registered as custom page sizes.

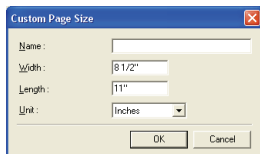

Area

Select the area to be scanned.

→ Area settings here are overridden in the following cases:

- When the [Auto-detection] page size is selected
- When [Text Orientation Recognition] is enabled on the [Image processing] tab sheet

→ When [Deskew] is enabled on the [Basic] tab sheet, the specified area may be displaced when scanning.

Area Window

The size indicated for the Area window corresponds to the page size setting, and the area within the panel indicates the current scanning area. The scanning area can be adjusted by dragging the handles bordering the Area window with your mouse.

→ With CapturePerfect, the last scanned image appears in the Area window.

Margin

This control adjusts the top, bottom, left and right margins around the scanning area so that you can expand the scanning area to include the edges of a document, or reduce it to avoid black frames around scanned images.

→ If the edges of documents are missing from scanned images, move the slider to the right to expand the scanning area.

→ To eliminate the black frame around scanned images, reduce the scanning area by moving the slider to the left.

→ The measurement units for margins are determined by the [Unit] setting.

Preview Button (TWAIN driver only)

Click the [Preview] button to scan one document page and display its preview image in the Area window.

Brightness/Contrast Adjustment

This section describes the procedure for adjusting the brightness and contrast for scanning.

- In the ISIS/TWAIN driver properties dialog box, click the [Brightness] tab → adjust the [Brightness] slider and [Contrast] slider to adjust the brightness and contrast for scanning.

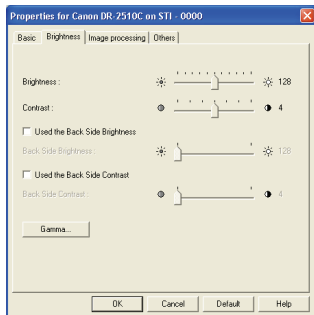

The settings you can specify are as follows:

- **[Brightness]**
Adjusts the brightness of images to be scanned.
 - If images are too dark or if text on the back bleeds through, drag the slider to the right to increase the brightness.
 - If images are too light, drag the slider to the left to decrease the brightness.
- **[Contrast]**
Adjusts the contrast of images to be scanned.
- **[Used the Back Side Brightness] Check Box**
If the brightness of the front and back of the document pages is different, select this check box to adjust only the brightness of the back side.
- **[Used the Back Side Contrast] Check Box**
If the contrast of the front and back of the document pages is different, select this check box to adjust only the contrast of the back side.

The availability of brightness and contrast settings are as follows, according to the setting selected in the [Mode] drop-down list on the [Basic] tab sheet.

Scanning mode	Brightness	Contrast	Back Side Brightness	Back Side Contrast
Black and White	○	○	○	○
Error Diffusion	○	○	○	○
Advanced Text Enhancement	○	—	—	—
Advanced Text Enhancement II	○	○	—	—
256-level Gray	○	○	○	○
24-bit Color	○	○	○	○
Auto Color Detection	○	○	○	○

○: Available for setting —: Not available for setting, or automatically set

Gamma Curve Settings

This section describes the procedure for adjusting the gamma level for scanning documents.

- 1 In the ISIS/TWAIN driver properties dialog box, click the [Brightness] tab → click [Gamma].

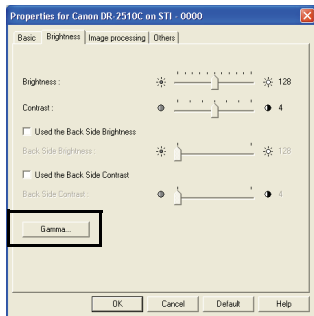

- 2 Select the [Custom] check box in the [Gamma Settings] dialog box → specify the settings as necessary.

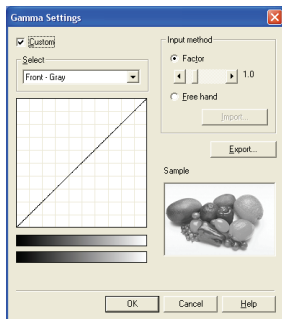

The settings you can specify are as follows:

- **Select**
Select the side and color for the custom setting.
 - The color bar and color of the sample image are changed to show the specified color.

- **Input method**
Select the setting method for gamma correction.
- **[Factor]**
Move the slider to the left or right to adjust the gamma correction factor between 0.2 and 5.0.
 - The gamma correction value, Gamma Curve Graph, and sample image color are interlinked.
 - Clicking a point in the Gamma Curve Graph with your mouse changes the gamma curve and color of the sample image to match that point.
 - You can also move the gamma curve by dragging it with the mouse.
- **[Freehand]**
The output value for a particular input value in the gamma table can be specified with the mouse.
 - Click any point in the Gamma Curve Graph to set that point as an output value.
 - Drag the mouse on the Gamma Curve Graph to set the output value according to the mouse movement.
- **[Import]**
Clicking this button loads gamma table data (*.png file) that was previously stored with the [Export] button.
 - Imported gamma data is reflected in the Gamma Curve Graph.
- **[Export]**
Clicking this button exports the custom gamma curve settings as a gamma table file (*.pxg.)

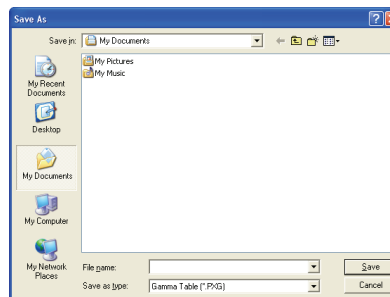

NOTE

When the [Custom] check box in the [Gamma Settings] dialog box is selected, all settings on the [Brightness] tab sheet are set automatically.

Image Contour Adjustment

This section describes the procedure for adjusting the contours of the scanned image.

- 1 In the ISIS/TWAIN driver properties dialog box, click the [Image processing] tab → adjust the [Edge emphasis] slider to adjust the contours of the scanned image.

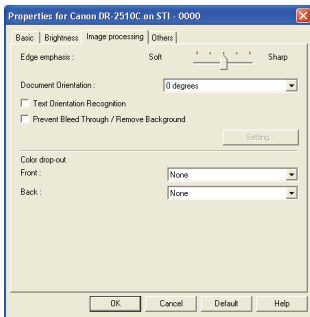

Move the slider toward [Soft] to soften the image contours, or toward [Sharp] to sharpen the image contours.

Image Rotation

This section describes the procedure for rotating the orientation of the scanned image.

- 1 In the ISIS/TWAIN driver properties dialog box, click the [Image processing] tab → select the angle to rotate the image from the [Document Orientation] drop-down list.

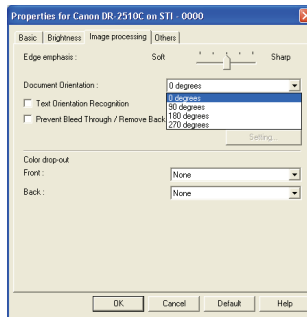

NOTE

The scanned image will be rotated as follows, according to the orientation of the placed document and the specified angle.

Document: face down				
Document Orientation (clockwise)	0 degrees	90 degrees	180 degrees	270 degrees
Scanned Image				

Correcting Text Orientation

This section describes the procedure for automatically correcting the orientation of the text when scanning.

- 1 In the ISIS/TWAIN driver properties dialog box, click the [Image processing] tab → select the [Text Orientation Recognition] check box.

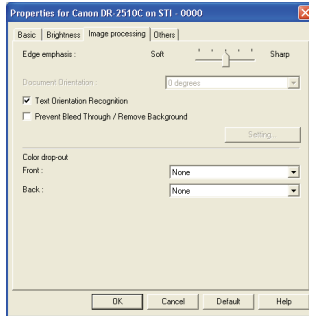

NOTE

- When the [Text Orientation Recognition] check box is selected, the [Image Rotation] and area settings in the [Scan Area] dialog box are disabled.
- Some application programs do not support text orientation recognition. Please disable [Text Orientation Recognition] if your application program operates abnormally when it is enabled.

Removing the Document Background/Preventing Bleed Through

This section describes the procedure for setting to reduce bleed through when scanning thin document pages and pages with dark content on the back side, or to remove the background from document images.

- 1 In the ISIS/TWAIN driver properties dialog box, click the [Image processing] tab → select the [Prevent Bleed Through / Remove Background] check box → click [Setting].

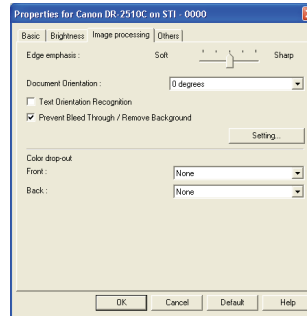

- 2 Adjust the [Removal level] slider to set the level of bleed through prevention or background removal.

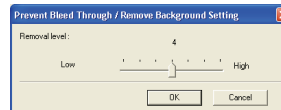

Omitting a Specific Color

This section describes the procedure for setting to omit borders and ruled lines of a specified color (red, green, or blue) from the scanned image.



If you select [24-bit Color] or [Auto Color Detection] from the [Mode] drop-down list in the [Basic] tab, you cannot specify this setting.

- In the ISIS/TWAIN driver properties dialog box, click the [Image processing] tab → select the color to omit from the [Front] and [Back] drop-down lists under Color drop-out, as necessary.

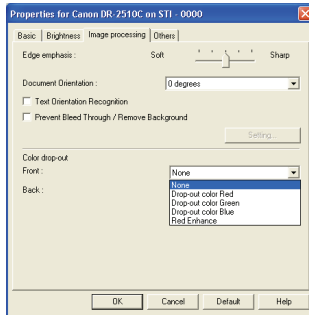

You can specify different settings for the front and back side of the document.

Enhancing the Red Color

This section describes the procedure for setting the scanner to enhance the red color when performing black-and-white scanning.



If you select [24-bit Color] or [Auto Color Detection] from the [Mode] drop-down list of the [Basic] tab, you cannot specify this setting.

- In the ISIS/TWAIN driver properties dialog box, click the [Image processing] tab → select [Red Enhance] from the [Front] and [Back] drop-down lists under Color drop-out.

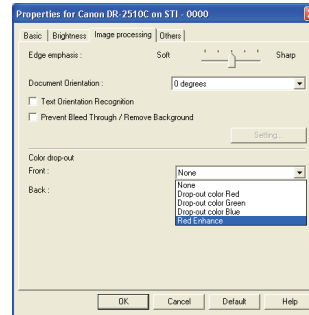

You can set specify different settings for the front and back side of the document.

Rapid System Recovery

This section describes the procedure for setting the system recovery method used by the scanner when document feeding stops due to a paper jam or other error during scanning.

- 1 In the ISIS/TWAIN driver properties dialog box, click the [Others] tab → select the [Rapid recovery system] check box → click [OK].

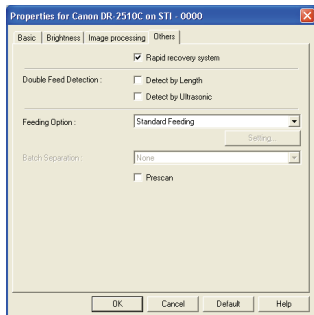

If you select [Rapid recovery system] and a paper jam or other error causes document feeding to stop while scanning, scanning stops without sending an error notification to the application program. After you clear the paper jam or resolve the error, you can resume the normal scanning operations.

Double Feed Detection

This section describes the procedure for setting the scanner to stop document feeding when double feeding of document pages is detected.

- 1 Click the [Others] tab → select the [Detect by Length] or [Detect by Ultrasonic] (for the DR-2510C only) check box under [Double Feed Detection] → click [OK].

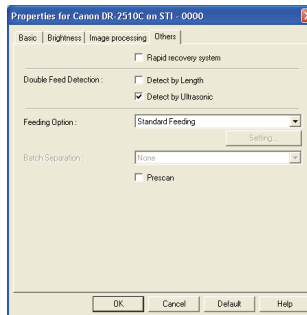

- Details of each detection method are indicated below.

[Detect by Length]

This detection method is effective when scanning documents of the same size. It detects double-feeding when a document is 2.0" (50 mm) longer or 2.0" (50) mm shorter than the standard length (the length of the first document). Feeding is stopped when a double-feed is detected.

[Detect by Ultrasonic]

This detection method is effective when scanning documents of different sizes. It uses ultrasonic waves to detect the gap between documents when more than two sheets of paper are fed at the same time. Feeding is stopped when a double-feed is detected.

- The two detection methods can be used at the same time.
- When the documents overlap by less than 2.0" (50 mm) or are stuck together due to static electricity, double-feeding may not be able to be detected correctly using ultrasonic.

Feeding Options

This section describes the procedure for selecting the method for feeding documents.

- 1 Click the [Others] tab → select the document feeding method in [Feeding Option].

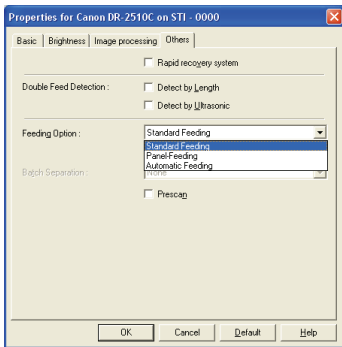

NOTE

- Details of each feeding method are indicated below.

[Standard Feeding]

This feeding method is good for scanning small batches of documents that are loaded one batch at a time: scanning stops when the loaded documents have been scanned.

[Panel Feeding]

This feeding method is good for scanning batches of documents of different sizes: after loading the documents, press the Job button (assigned as a Start button on the scanner) to start scanning, and press the assigned Stop button to stop scanning.

- When scanning documents with different-size pages, after loading the documents, you can adjust the document guide position.

[Automatic Feeding]

This feeding method is good for scanning batches of same-size documents: scanning starts when the scanner detects loaded documents, and stops when you press the Stop button.

- When [Automatic Feeding] is selected, the [Setting] button is enabled to allow setting the delay time from when a loaded document is detected until scanning starts. The delay time can be set from 0 to 60 seconds.



Batch Separation (ISIS driver only)

When the separation timing to use when scanning starts with batch separation enabled in the application. (If [Standard Feeding] is selected, batch separation is disabled.)

If you selected [Panel Feeding] or [Automatic Feeding] for the feeding method:



[Auto]

Document batches are separated automatically.

[Panel]

Document batches are separated when the [Batch Separation] button on the Scan Panel is pressed. (See "Using the Scan Panel," on p. 28.)

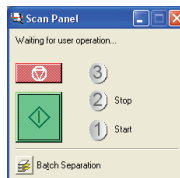

Prescan

This section describes the procedure for checking a scanned image and adjusting the brightness and contrast accordingly.

- 1 In the ISIS/TWAIN driver properties dialog box, click the [Others] tab → select the [Prescan] check box.

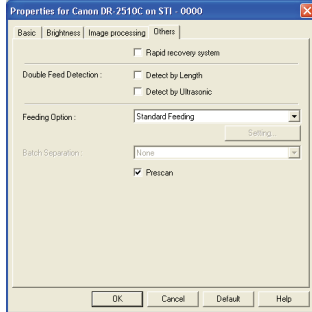

- 2 Specify the location, file name, and file format to save the image → click [Save] to start scanning.

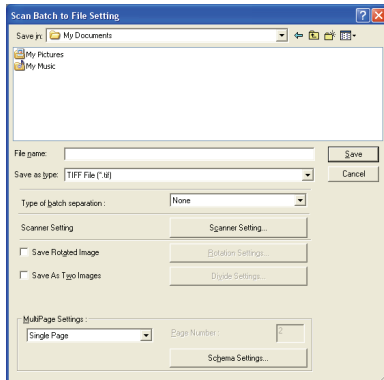

When scanning is complete, the Prescan dialog box is displayed.

- 3 Check the displayed preview image → adjust [Brightness] and [Contrast] as necessary using the sliders or up/down buttons → click ◊ (Start) to save the scanned image.

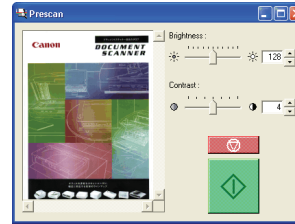

NOTE

The [Prescan] dialog box is for scanning after adjusting the brightness and contrast according to the results of the first document. You can enlarge the image displayed in the [Prescan] dialog box. (Left-click the image displayed in the dialog box to enlarge it, and right-click the image displayed in the dialog box to reduce it.)

If you change the brightness and contrast values, the image displayed in the dialog box reflects these new values. Click the Start button to start scanning with the adjusted brightness and contrast. Click the Stop button to stop scanning.

Registering Scanning Conditions

This section describes the procedure for registering specified scanning conditions.

1 Specify the scanning conditions as necessary on the [Basic] tab, [Brightness] tab, [Image processing] tab, and [Others] tab of the ISIS/TWAIN driver properties dialog box.

2 Click the [Basic] tab → click [Save].

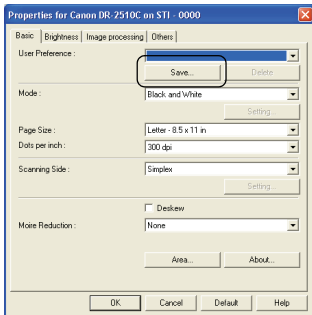

3 Enter a name for [Save user preference as] → click [OK].

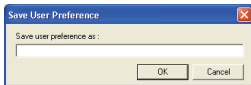

Checking the Version

This section describes the procedure for checking the version of the ISIS/TWAIN driver you are currently using.

1 In the ISIS/TWAIN driver properties dialog box, click the [Basic] tab → click [About].

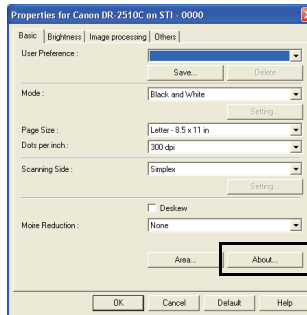

2 Check the content of the [About] dialog box → click [OK].

Chapter 5 Job Registration Tool Settings

1. Starting the Job Registration Tool.....	55
2. Job Registration Tool Settings Dialog Box.....	56
Job Registration Tool Dialog Box.....	56
New/Editing Dialog Box.....	56
Admin Dialog Box.....	60

1. Starting the Job Registration Tool

The Job Registration Tool is a TWAIN-compliant application program that installs with the ISIS/TWAIN driver. Use the following procedure to start the Job Registration Tool.

- 1 From the Windows task bar, click [Start] → point to [All programs] → [Canon DR-2510C] or [Canon DR-2010C] → click [Job Registration Tool].

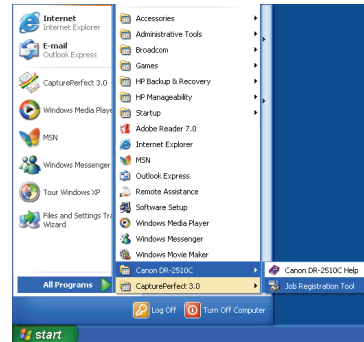

2. Job Registration Tool Settings Dialog Box

The Job Registration Tool Settings dialog box provides access to the [New/Editing] dialog box and the [Admin] dialog box, and the [New/Editing] dialog box provides access to the function setting dialog boxes.

Job Registration Tool Dialog Box

This dialog box appears when the Job Registration Tool is started from the Windows Start menu.

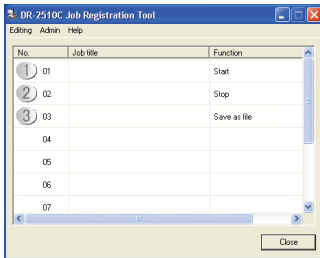

Job Button Settings List

The displayed job buttons correspond to those on the scanner, showing their currently assigned settings. Clicking on the job buttons (①, ② and ③) or [New/Editing] in the [Editing] menu opens the [New/Editing] dialog box.

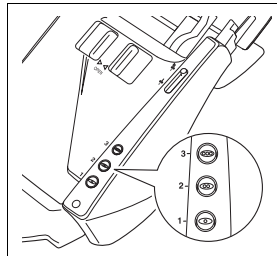
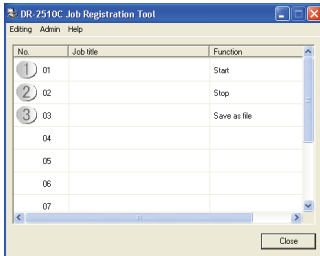

Job Buttons

[Close] Button

Closes the [Job Registration Tool] dialog box.

New/Editing Dialog Box

The [New/Editing] dialog box appears when you click a Job button in the [Job Registration Tool] dialog box or click [New/Editing] from the [Editing] menu. The [New/Editing] dialog box appears as follows depending on the function settings registered to the Job buttons.

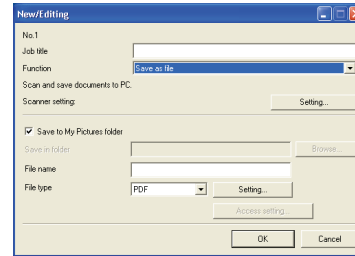

Save as File

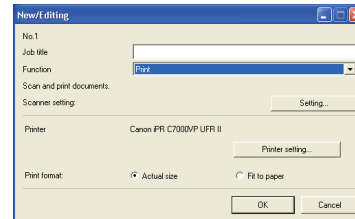

Print

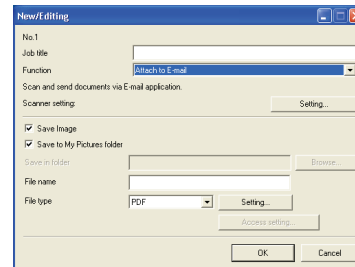

Attach to E-mail

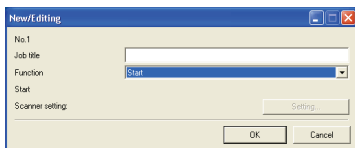

Start

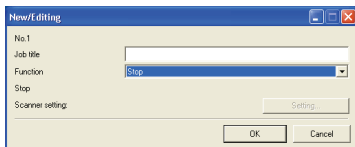

Stop

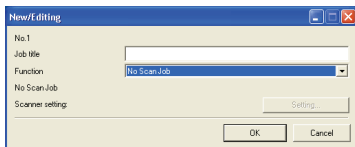

No Scan Job

Settings Common to Each Function



■ Job Number [No. 1 to No. 10]

Displays the selected job button number. Settings are registered to the job button with the displayed number.

■ Job title

Enter the job title to be displayed for [Job title] in the [Job Registration Tool] dialog box.

- Job titles may consist of up to 40 alphanumeric characters.
- Job titles other than "Start" and "Stop" are not displayed in the [Scan Panel] dialog box.

■ Function

Select the function to set for each job.



When you change functions, the [New/Editing] dialog box is changed.

■ Scanner setting

When the [Save as file], [Print], or [Attach to E-mail] function is selected in the [Function] box, scanner settings are enabled, and you can press the [Setting] button to specify scanner settings.

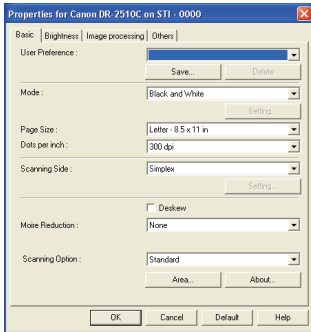

NOTE

For more information on the scanner settings, see Chapter 4, "ISIS/TWAIN Driver Settings."

Settings to Save Image Files

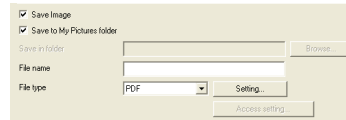

■ [Save Image] Check Box

This check box appears when [Attach to E-mail] is selected in the [Function] box. Select this check box to save scanned images to the My Pictures folder or a folder that you specify.

■ [Save to My Pictures folder] Check Box

Saves image files to [My Pictures] in the [My Documents] folder. When this check box is not selected, [Save in folder] and [Access setting] are enabled.

■ Save in folder

When the [Save to My Pictures folder] check box is not selected, this entry box is enabled for you to enter a folder name in which to save scanned images. You can also select a folder by clicking [Browse].

■ File name

Enter a name for the files to save.

- File names may consist of up to 32 alphanumeric characters.
- A time stamp is appended to the file name indicating the time of scanning.

■ File type

Select the file format for saved files from the File type drop-down list.

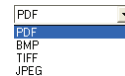

NOTE

Selecting [TIFF] or [PDF] enables the [Setting] button.

■ [Setting] Button

This button is enabled to display the corresponding setting dialog box when the [TIFF] or [PDF] file format is selected.

TIFF Settings Dialog Box

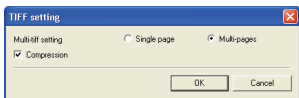

[Multi-tiff setting]

Select the method for saving image files when scanning multi-page documents.

- Select [Single page] to save each page in its own image file.
- Select [Multi pages] to save all pages in one image file.

[Compression] Check Box

Select this check box to compress images saved to files. Black and white (binary) images are compressed in CCITT Group 4 format, and grayscale and color images in JPEG format. When this check box is not selected, the saved files are larger.

- CCITT Group 4: This compression format was designed for data communications (such as with fax devices) of black and white (binary) images.
- JPEG: This compression format is for saving grayscale and color images. When the [Compression] check box is selected, a standard level of JPEG compression is applied.
- If your application program does not support the above compression formats, you may be unable to open scanned image files. In this case, disable [Compression] when scanning.

PDF Settings Dialog Box

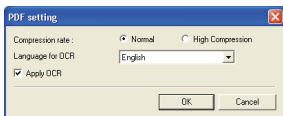

Compression rate

Select the compression rate for PDF files.

- Select [Normal] to save files with standard compression.
- Select [High Compression] to save files with high compression. Although file size is reduced, image quality may be slightly degraded.

The Compression rate setting is enabled when the scanner is set to [256-level Gray] or [24-bit Color] mode. When the [Black and White] or [Error Diffusion] binary image scanning mode is selected, the file size depends on the content of the scanned document.

Language for OCR

When the [Apply OCR] check box is selected, the target language for OCR can be selected in the list box.

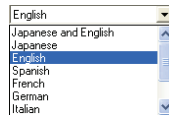

NOTE

Chinese OCR with the [Simplified Chinese] or [Traditional Chinese] settings requires a Chinese language environment to display properly.

[Apply OCR] Check Box

Select this check box to enable recognition of the text within images and to save the recognized text data with the image. Characters within document images are recognized as text and saved as appended text data in PDF (*.pdf) files.

[Access setting] Button

This button is enabled when the [Save to My Pictures folder] check box is not selected, allowing you to enter the user name and password required to access the shared network folder specified for [Save in folder].

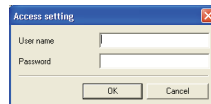

NOTE

- Access to shared network folders may be restricted to users with certain access permission. In this case, users cannot access the shared folder without entering the correct user name and password.
- Confirm the access rights for the shared network folder with the network administrator, and then enter the user name and password.

Settings to Print Scanned Images



- **[Printer]**
Shows the printer to use for printing images. Click [Printer setting] to change the printer settings.
- **[Print format]**
Select whether to resize images for printing.
 - Select [Actual size] to print images in the same size as their original documents.
 - Select [Fit to paper] if the scanned documents are larger than the printer paper, to resize the images to the printer paper size.
- **Buttons**
 - [OK] Button**
Click this button to accept the setting changes and return to the [Job Registration Tool] dialog box.
 - [Cancel] Button**
Click this button to reject the setting changes and return to the [Job Registration Tool] dialog box.

Admin Dialog Box

This dialog box appears when you click [Admin] in the [Job Registration Tool] dialog box. You can set [Capacity Warning Settings], [Show Monitor Dialog Setting], [Maximum size of attached file] and [Back Up/Restore].

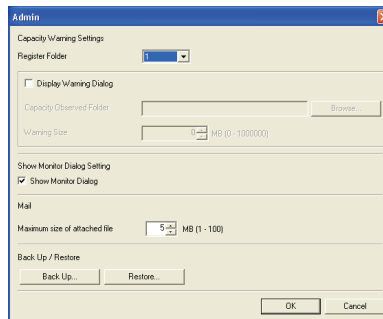

Settings for Monitoring the Folder for Saved Images

- **[Capacity Warning Settings]**
The capacity warning settings allow you to specify in advance the folder for saving image files, and the space to be available for saving files. If the space required to save a file would exceed the specified warning size, a warning message appears when starting to scan or during scanning.

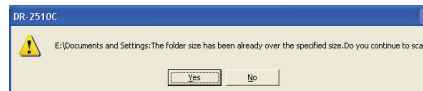

A warning size (capacity) can be specified for up to five folders. To register a warning size for a folder, click the number (1 to 5) of the folder in the [Register Folder] box.

- **[Display Warning Dialog] Check Box**
Select this check box when you want to limit the space available in a destination folder by registering the folder number and specifying a warning size.

■ **[Capacity Observed Folder]**

Specify a folder to monitor for available space.

■ **[Warning Size]**

Enter the maximum total size for all files saved to the specified folder.

- When saving to removable storage media such as a CD-R, specify the maximum capacity of the media.
- When folder monitoring ([Display Warning Dialog]) is enabled, a warning message appears when starting to scan if the total size of the files in the specified folder exceeds the specified limit.
- If a warning message appears, follow the instructions in the message to either continue scanning or change the save destination before continuing scanning.

Monitor Job Dialog Settings

■ **[Show Monitor Dialog] Check Box**

Select this check box to display the [Monitor for DR-2510C] or [Monitor for DR-2010C] dialog box to display job progress while scanning.

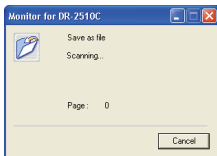

Setting the Maximum Size of E-Mail Attachments

■ **[Maximum size of attached file] Box**

Specify the maximum image file size that can be attached to an e-mail message when [Attach to E-mail] is selected. When the scanned image size reaches the specified maximum, a message appears and scanning stops.

The maximum size of attached files must not exceed the limit determined by the mail server. Ask your e-mail system administrator for the attachment size limit of the mail server.

Job Backup Settings

■ **[Back Up] Button**

Writes a backup file (*.reg) of registered job data to the specified folder.

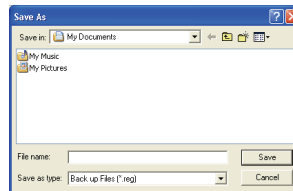

■ **[Restore] Button**

Restores the job data from a stored backup file (*.reg.)

If a currently registered job number is the same as that of an existing backup file, the existing backup file is overwritten by the registered job.

■ **Buttons**

[OK]

Click this button to accept changes and return to the [Job Registration Tool] dialog box.

[Cancel]

Click this button to reject changes and return to the [Job Registration Tool] dialog box.

Chapter 6 Maintenance

1. Regular Maintenance	62
Cleaning the Scanner.....	62
Cleaning the Inside of the Scanner	62
Cleaning the Sensor Glass and the Rollers	63
2. Removing and Attaching the Rollers and Document Holding Guide	65
Roller Replacement Cycle.....	65
Removing/Attaching the Feeding Roller.....	65
Removing/Attaching the Retard Roller	67
Removing/Attaching the Document Holding Guide.....	69
Resetting the Counter.....	70

1. Regular Maintenance

Clean the scanner on a regular basis, as described below, to maintain peak scanning quality.

CAUTION

- When cleaning the scanner and the inside of the scanner, turn OFF the power switch and disconnect the power cord from the power outlet.
- Do not use spray cleaners to clean the scanner. Precision mechanisms, such as the light source, may get wet, and cause a malfunction.
- Never use paint thinner, alcohol, or other organic solvents to clean the scanner. Such solvents can damage or discolor the exterior of the scanner, or create a risk of fire or electrical shock.

Cleaning the Scanner

To clean the exterior of the scanner, dampen a cloth with water or a mild detergent, wring the cloth out thoroughly, and then wipe the dirt away. Then use a dry, soft cloth to wipe away any moisture.

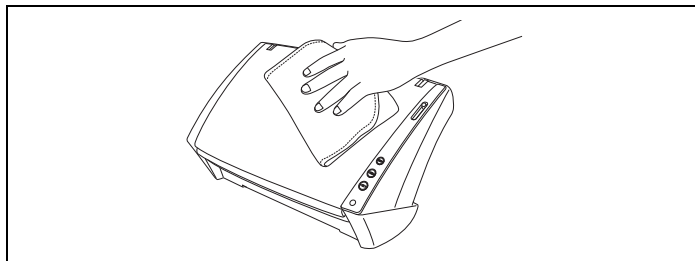

Cleaning the Inside of the Scanner

Dust or paper particles inside the scanner may cause lines or smudges to appear on scanned images. Use compressed air to periodically clean dust and paper particles from the document feed opening and the inside of the scanner. After finishing a large scanning job, turn OFF the scanner and then clean out any paper particles remaining inside the scanner.

Cleaning the Sensor Glass and the Rollers

If scanned images contain streaks, or if the scanned documents become dirty, the sensor glass or rollers inside the scanner may be dirty. Clean them periodically.

1 Open the document feed tray (See p. 20).

2 Press the OPEN knob from both sides (①), and pull the front unit out and downward to open it (②).

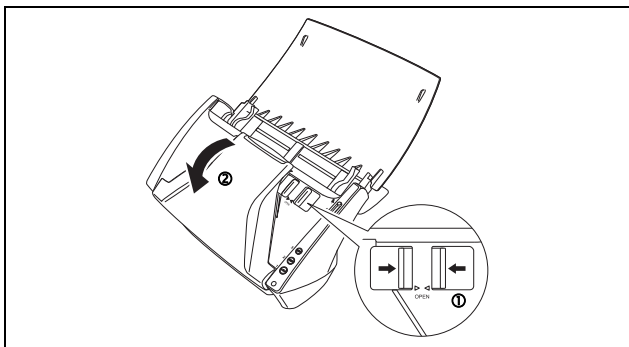

3 Use compressed air to remove dust and paper particles from the inside of the scanner.

4 Use a clean dry cloth to wipe dirt off the sensor glass.

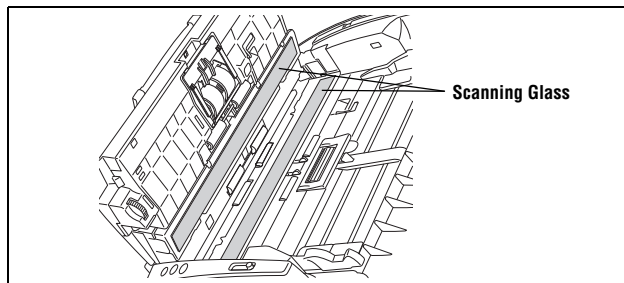

Wipe both the front and back sensor glasses.

CAUTION

Do not spray water or neutral detergent directly on the scanner. Precision mechanisms, such as the light source, may get wet, and cause a malfunction.

IMPORTANT

Scratches on the sensor glass may cause marks on the images, as well as feeding errors. If there are scratches on the sensor glass, contact your local authorized Canon dealer or service representative.

5 Clean the ① rollers by wiping the exposed part without turning them.

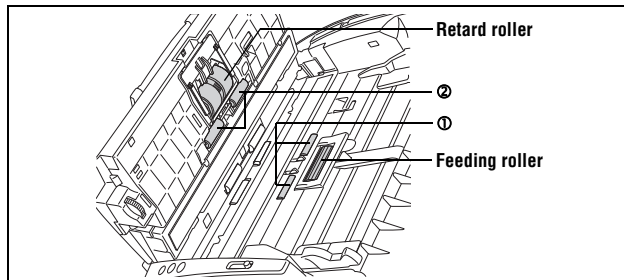

Clean the ② rollers while turning them. Wipe the rollers with a cloth that has been dampened with water and thoroughly wrung out, and then use a dry, soft cloth to wipe away any moisture.

- 6** Clean the ③ rollers by wiping the exposed part without turning them.

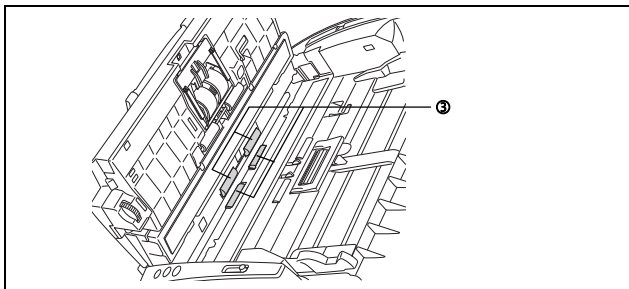

- 7** Wipe the document holding guide with a cloth that has been dampened with water and thoroughly wrung out.

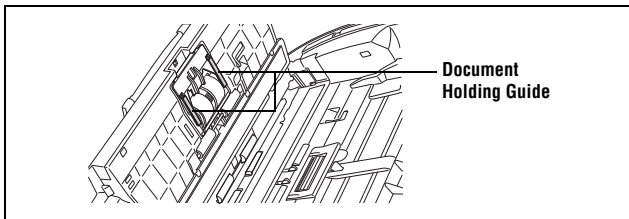

- 8** Remove the retard roller and feeding roller (See p. 65 and p. 67.).

IMPORTANT

Remove the retard roller and feeding roller from the scanner to clean them, and make sure to reattach them to the scanner when cleaning is finished.

- 9** Wipe the removed rollers with a cloth that has been dampened with water and thoroughly wrung out.

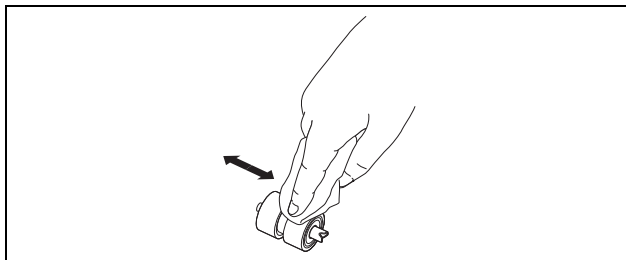

- 10** Reattach the retard roller and feeding roller (See p. 66 and p. 68.).

- 11** Close the front unit by gently pushing it up on both sides until it clicks into place. Make sure that the front unit is completely closed by pushing until you hear a click.

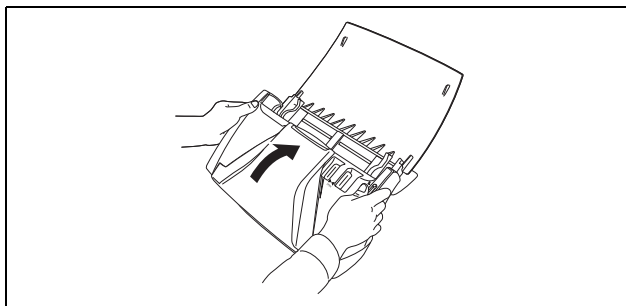

- 12** Close the document feed tray.

2. Removing and Attaching the Rollers and Document Holding Guide

To clean or replace the feeding roller, retard roller, or document holding guide, remove and then attach the parts as described in each respective section.

! CAUTION

Do not use excessive force when removing or attaching the rollers and document holding guide. Doing so may damage them.

Roller Replacement Cycle

When the rollers have fed more than 30,000 pages, a roller replacement message appears on the computer. Purchase an exchange roller kit and replace the feeding roller and the retard roller.

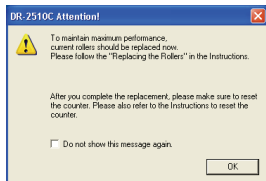

! IMPORTANT

- Rollers are consumable parts. When the rollers start to wear out, paper jams and misfeeds may occur more often. When this happens, purchase an exchange roller kit and replace the feeding roller and the retard roller.
- If misfeeds occur often, check the rollers for wear, and replace them if necessary before the message is displayed.
- Make sure to reset the counter after replacing the rollers (See "Resetting the Counter," on p. 70.).
- For information about the exchange roller kit (feeding roller, retard roller,) contact your local authorized Canon dealer or service representative.

Removing/Attaching the Feeding Roller

To remove or attach the feeding roller, follow the procedure below.

! CAUTION

Use caution when removing or attaching the feeding roller. Using excessive force may cause damage or personal injury.

Removing the Feeding Roller

- 1 Open the document feed tray (See p. 20).
- 2 Press the OPEN knob from both sides (①), and pull the front unit out and downward to open it (②).

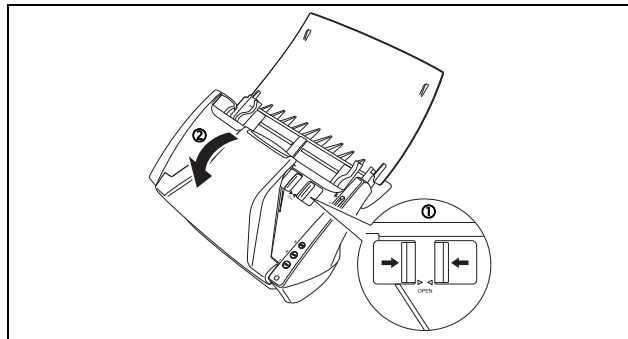

- 3** Open the roller cover on the main unit by placing your fingers in the grooves and pulling it down.

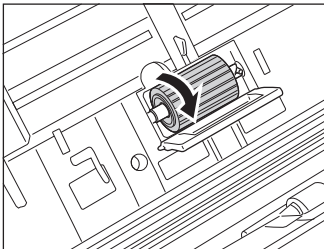

- 4** Lift up the roller fixing lever (①), and slide it to the left (②).

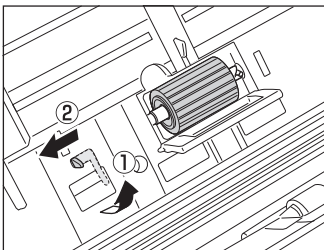

- 5** Remove the feeding roller by moving it to the left to detach it from its shaft, and pull it out of the slot.

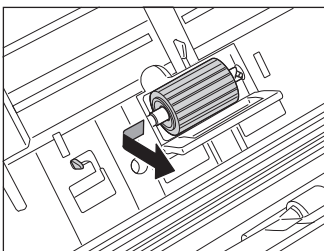

Attaching the Feeding Roller

- 1** Insert the feeding roller into the slot inside the roller cover, and align the notch on the roller with the shaft on the main unit.

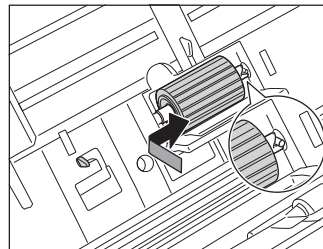

- 2** Slide the roller fixing lever to the right to lock the roller into the hole on the left of the feeding roller.

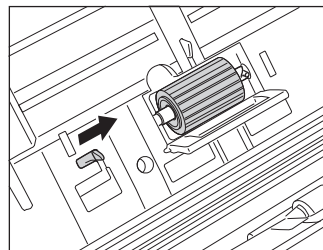

- 3** Push down the lever to lock the shaft of the feeding roller into place.

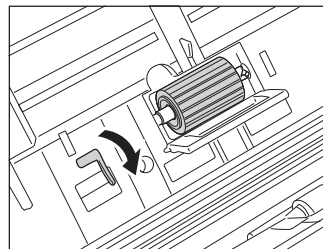

- 4** Close the roller cover. Make sure that the cover is completely closed by pushing until you hear a click.

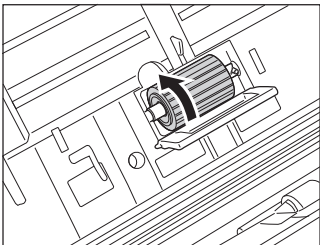

- 5** Close the front unit by gently pushing it up on both sides until it clicks into place. Make sure that the front unit is completely closed by pushing until you hear a click.

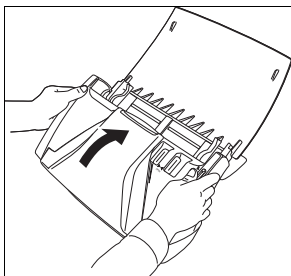

- 6** Close the document feed tray.

Removing/Attaching the Retard Roller

To remove or attach the retard roller, follow the procedure below.

! CAUTION

Use caution when removing or attaching the retard roller. Using excessive force may cause damage or personal injury.

Removing the Retard Roller

- 1** Open the document feed tray (See p. 20).
- 2** Press the OPEN knob from both sides (①), and pull the front unit out and downward to open it (②).

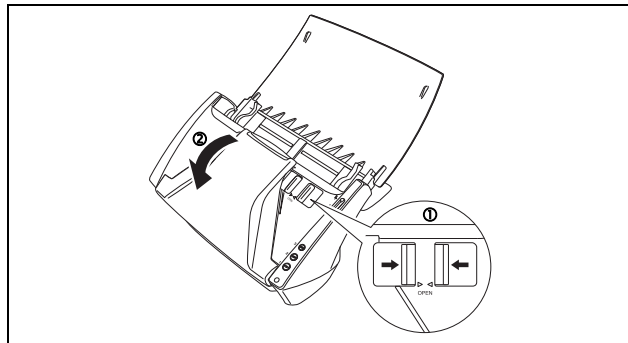

- 3** Grasp the ends of the roller cover inside the front unit and pull it down to open it.

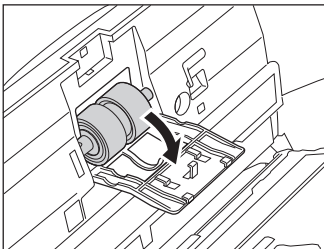

- 4** Lift up the roller fixing lever (①), and slide it to the right (②).

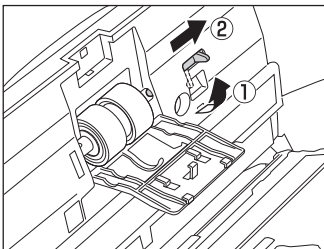

- 5** Remove the retard roller by moving it to the right to detach it from its shaft, and pull it out.

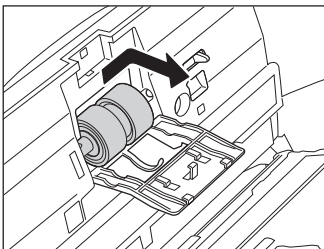

Attaching the Retard Roller

- 1** Insert the retard roller into the slot inside the roller cover, and align the notch on the roller with the shaft on the front unit.

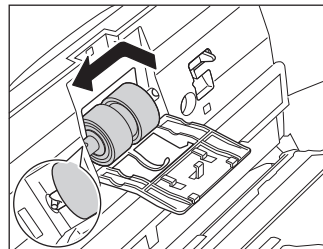

- 2** Slide the roller fixing lever to the left to lock the roller into the hole on the left of the retard roller.

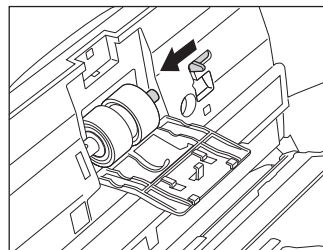

- 3** Push down the lever to lock the shaft of the feeding roller into place.

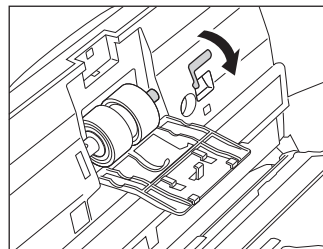

- 4** Close the roller cover. Make sure that the cover is completely closed by pushing until you hear a click.

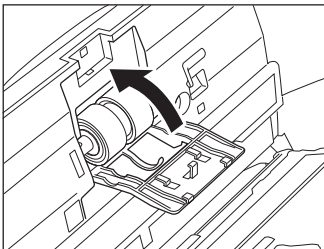

- 5** Close the front unit by gently pushing it up on both sides until it clicks into place. Make sure that the front unit is completely closed by pushing until you hear a click.

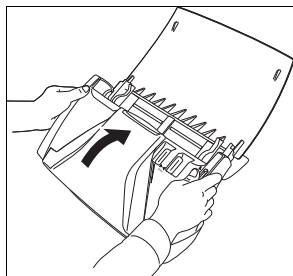

- 6** Close the document feed tray.

Removing/Attaching the Document Holding Guide

To remove or attach the document holding guide, follow the procedure below.

! CAUTION

Use caution when removing or attaching the document holding guide. Using excessive force may cause damage or personal injury.

Removing the Document Holding Guide

- 1** Open the roller cover, and slide the document holding guide backwards to remove it.

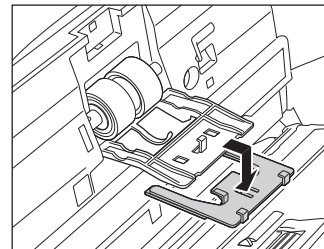

Attaching the Document Holding Guide

- 1** Fit the hooks (four) of the document holding guide onto the roller cover, and slide the document holding guide forwards to attach it.

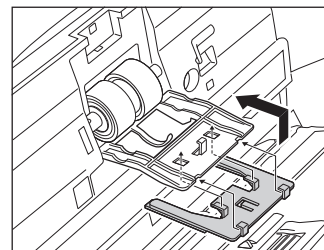

Resetting the Counter

After replacing the feed rollers, open the counter settings dialog box and reset the counter.

1 From the Windows task bar, click [Start] → [Control Panel].



2 Double-click [Printers and Other Hardware] in the working field → click [Scanners and Cameras].

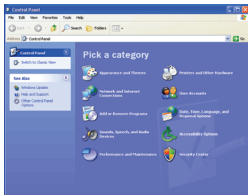

Control Panel (Category View)

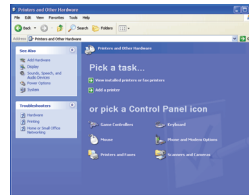

Printers and Other Hardware

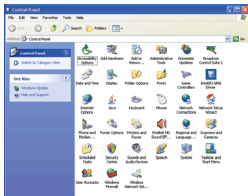

Control Panel (Classic View)

3 Double-click [Scanners and Cameras].

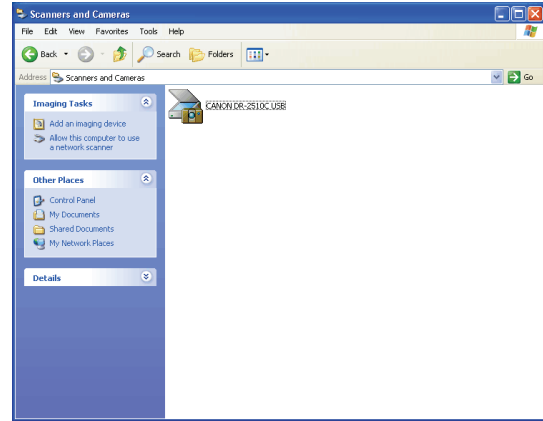

4 Right-click [CANON DR-2510C USB] or [CANON DR-2010C USB] → click [Properties].

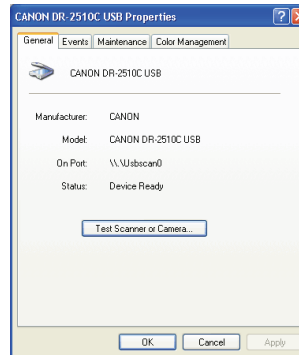

5 Click the [Maintenance] tab → [Reset].

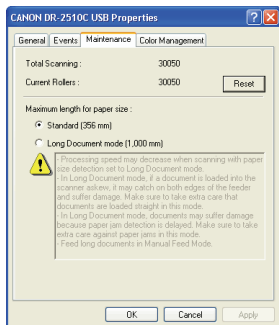

6 Confirm that the counter for the selected roller is set to 0 → click [OK].

Chapter 7 Troubleshooting

1. Troubleshooting	72
2. Uninstalling Software	75
Uninstalling the ISIS/TWAIN Driver and Job Registration Tool	75
Uninstalling CapturePerfect 3.0	76

1. Troubleshooting

This section describes the possible problems that might occur during use of the scanner and how to solve them.

The Scanner Does Not Turn ON	(P. 72)
The Scanner Is Not Recognized	(P. 72)
Slow Scanning Speed	(P. 73)
Scanning Is Not Performed	(P. 73)
Documents Do Not Feed Properly	(P. 73)
Saved Image Files Do Not Open	(P. 74)
Scanning Results Are Not as Expected	(P. 74)

If, after consulting this section, you still cannot resolve the problem, contact your local authorized Canon dealer or service representative.

× **The Scanner Does Not Turn ON**

Check the following if the scanner does not turn ON:

- Is the power switch turned ON?
- Is the power cord connected correctly?
- Is the power cord inserted into the power outlet?

For details on connecting the power cord, see "Chapter 2 Setup - Connecting the Scanner to the Computer," on p. 15.

× **The Scanner Is Not Recognized**

The following are possible causes of the PC failing to recognize the scanner. Check each possible cause.

Problem	The scanner is not connected correctly
Solution	Make sure that the scanner and the computer are connected correctly with the USB cable. (See "Chapter 2 Setup - Connecting the Scanner to the Computer," on p. 15.)

Problem	The scanner power is switched OFF.
Solution	Make sure that the scanner is switched ON. If the scanner is OFF, turn the scanner ON. (See "Chapter 2 Setup - Connecting the Scanner to the Computer," on p. 15.)
Problem	The scanner does not support your USB interface.
Solution	This product is not guaranteed to operate with all types of USB interfaces. Contact your local authorized Canon dealer or service representative for more information.
Problem	The scanner does not support the USB cable.
Solution	Use the USB cable provided with the scanner.
Problem	The USB hub is not compatible with the scanner.
Solution	Remove the USB hub.

× **Slow Scanning Speed**

The following problems might cause the scanning speed to be slow.

Problem	Other applications are running in the background on your PC.
Solution	Quit all other applications that are running.
Problem	Resident applications, such as anti-virus software, are draining memory resources.
Solution	Quit all resident applications.
Problem	Temporary files cannot be created in the TEMP folder, as there is not enough free space on the hard disk.
Solution	Delete unwanted files on the hard disk to increase free space on the hard disk.
Problem	The USB port you are using does not support Hi-Speed USB 2.0.
Solution	Scanning speeds are slower if your computer's standard USB interface is not compatible with Hi-Speed USB 2.0. (See p.11.) Use a computer that is equipped with USB that is compatible with Hi-Speed USB 2.0 as standard.
Problem	The USB cable does not support Hi-Speed USB 2.0.
Solution	Use the USB cable provided with the scanner.

Problem	The USB hub does not support Hi-Speed USB 2.0.
Solution	Remove the USB hub.

× **Scanning Is Not Performed**

Check the following if the scanner does not scan an image even though the scanning operation is performed:

- Has the scanner been properly recognized by the computer?
- Has the scanner driver been installed?
- Has the application software been installed correctly? Has the application software been set up correctly?
- Is there a problem in the PC system?



IMPORTANT

- If documents are not scanned normally even if the scanner setup is OK, a probable cause is that the scanner driver or application software is not running correctly. Re-install the scanner driver or application software.
- When system errors result in the scanner not functioning at all, turn OFF the scanner and wait at least ten seconds before turning it ON again. If the error continues to occur, restart the computer.
- When scanning continues, make sure that the last document scanned was scanned correctly.

× **Documents Do Not Feed Properly**

The following are possible causes of a document failing to feed properly. Check each possible cause.

Problem	Static electricity, etc., is causing the pages of the document to stick together, and they cannot be separated correctly by the scanner.
Solution	Before you place your document, thoroughly fan the stack of pages. (See "Feeding in the Page Separation Mode," on p. 21.)
Problem	Attempting to scan a document of a size, thickness, or weight that the scanner cannot scan.
Solution	Check the size, thickness, and weight of the document. For information on the type of documents that you can use with the scanner, see "1. Documents," on p. 18.

Problem **The rollers inside the scanner are dirty or worn.**
Solution Clean the rollers (See p.63.). If the rollers are worn, then they need to be replaced. Contact your local authorized Canon dealer or service representative to purchase a roller replacement kit.

For information on removing jammed documents, see "Clearing a Paper Jam," on p. 33.

× **Saved Image Files Do Not Open**

When image files saved by CapturePerfect 3.0 cannot be opened by other applications, the probable causes are as follows.

Symptoms **A multi-page TIFF file saved in CapturePerfect 3.0 cannot be opened by other applications.**
Problem The application you are using to open the TIFF file does not support multi-page TIFF files.
Solution Open the file with an application that supports multi-page TIFF files.

Symptoms **A TIFF file saved in CapturePerfect 3.0 cannot be opened by other applications.**
Problem If the TIFF file saved in CapturePerfect 3.0 has been compressed, the application you are using to open the TIFF file does not support the compression type that was used to save the file in CapturePerfect 3.0.
Solution Set the compression type for the image file to [None] and save the file again in CapturePerfect 3.0.

× **Scanning Results Are Not as Expected**

If there is a problem with the scanning result (e.g., the scanned image is not clear, or the image is striped or dirty,) the probable causes are incorrect ISIS/ TWAIN driver settings or a problem with the scanning unit inside the scanner. Scanning results can also become skewed if the ISIS/TWAIN driver has not been installed correctly, or the application in use does not support ISIS/TWAIN driver functions.

Symptoms **The scanned image is too dark (or faint.)**
Problem The [Brightness] setting is set incorrectly.
Solution If the image is dark, set a higher [Brightness] setting, or if the image is faint, set a lower [Brightness] setting.

Symptoms **Text or images on the rear side of your document appear in the scanned image.**

Problem The [Brightness] setting is too low, or the paper is too thin.
Solution Set a higher [Brightness] setting. If the paper is too thin, make a copy of the documents and then scan the copy. Alternatively, enable the [Prevent Bleed Through / Remove Background] setting.

Symptoms **Double-sided scanning is not possible.**

Problem [Scanning Side] is set to [Simplex].
Solution Set [Scanning Side] to [Duplex].

Symptoms **The scanned image is skewed.**

Problem The document has been fed at an angle (skew).
Solution Use the document guide adapter to prevent document skew, and select the [Deskew] check box in the Basic tab of the ISIS/TWAIN driver properties dialog box (See p.43.).

Symptoms **Lines, smudges, or dirt appear on the scanned image.**

Problem The scanning glass or rollers inside the scanner are dirty.
Solution Clean the scanning glass and rollers. If lines still appear on the image even after cleaning the scanning glass and rollers, the scanning glass inside the scanner may be scratched. Contact your local authorized Canon dealer or service representative.

Symptoms **The scanned image is abnormal in some applications.**

Problem A function not supported by the application was used.
Solution Some applications do not support functions such as auto-detection of the paper size. Scanning documents with an application such as this will result in an abnormal scanned image. Try scanning without setting auto-detection of the paper size.

2. Uninstalling the Software

If the ISIS/TWAIN driver, Job Registration Tool, or CapturePerfect 3.0 are not operating normally, follow the procedure below to uninstall them. Then, re-install the software from the DR-2010C/DR-2510C setup disc (See "2. Installing the Software," on p. 12.).

IMPORTANT

Log on to Windows as an Administrator.

1 From the Windows task bar, click [Start] → [Control Panel].

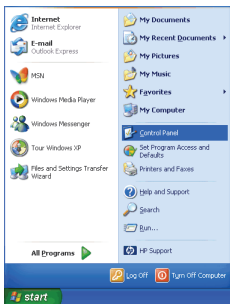

2 Double-click [Add or Remove Programs].

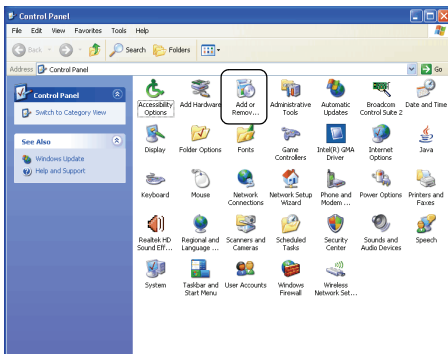

The [Add or Remove Programs] dialog box appears.



Uninstalling the ISIS/TWAIN Driver and Job Registration Tool

1 From the Programs list, click [Canon DR-2510C Driver] / [Canon DR-2010C Driver] (or [DR-2510C Job Tool] / [DR-2010C Job Tool]) → click [Remove].

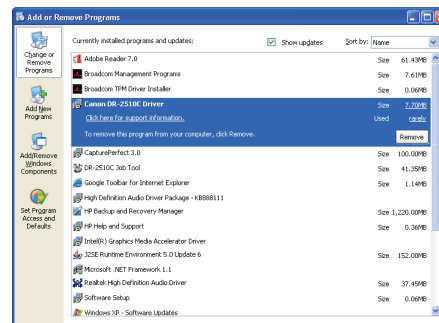

NOTE

If you clicked [DR-2510C Job Tool] / [DR-2010C Job Tool], click [Change/Remove].

2 Click [Yes] in the [DR-2510C Setup] / [DR-2010C Setup] dialog box.

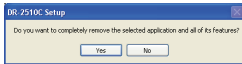

NOTE

To remove the Job Registration Tool, click [Yes] in the [Confirm File Deletion] dialog box.

3 Click [Finish].

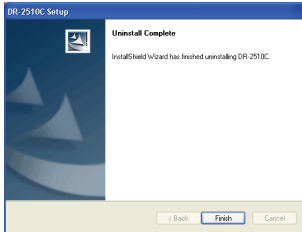

NOTE

When removing the Job Registration Tool, click [Yes To All] in the [Remove Shared File?] dialog box → click [Yes]. After the uninstallation procedure is complete, click [OK].

Uninstalling CapturePerfect 3.0

1 From the Programs list, click [CapturePerfect 3.0] → [Remove].

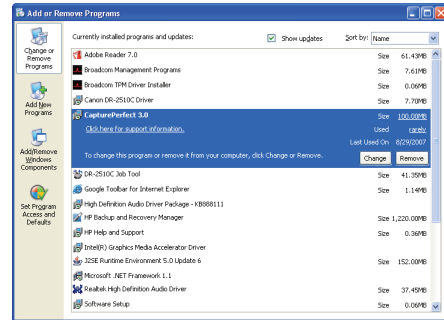

2 Click [Yes] in the [CapturePerfect 3.0 Setup] dialog box.

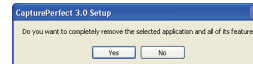

3 Click [Finish].

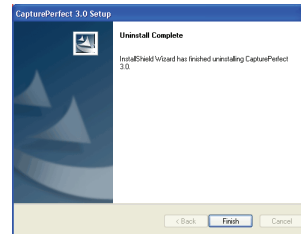

Chapter 8 Appendix

Specifications	77
Specifications.....	77
Replacement Parts.....	78
External Dimensions.....	79
 INDEX	 81

Specifications

Specifications

Main Unit

Type	Desktop sheetfed scanner
Scanning Document Size	
Plain Paper	
Size	Width: 1.97" to 8.5" (50 mm to 216 mm) Length: 2.12" to 14.02" (53.9 mm to 356mm)*
Paper weight: (Page separation mode)	14 to 32 lb bond (52 to 128 g/m ²) 0.0024" to 0.0059" (0.06 mm to 0.15 mm)
Paper weight: (Bypass mode)	11 to 42 lb bond (40 to 157 g/m ²) 0.002" to 0.0079" (0.05 mm to 0.20 mm) *You can scan documents up to 39.2" (1000 mm) long by setting the scanner to the Long Document mode. (See "Setting the Long Document Mode," on p. 35.)
Business Card	Size: 1.97" x 2.12" (50 mm x 53.9 mm) or larger
Paper weight:	140 lb bond (300g/m ²) 0.0138" (0.35 mm) or less
Card	Size: 2.12" x 3.37" (53.9 mm x 85.5 mm) (ISO/JIS standard)
Card thickness:	0.03" (0.76 mm) or less
Orientation:	horizontal feeding only Embossed cards can be scanned.
Document Feeding Method	Automatic
Scanning Sensor	Contact image sensor
Light Source	LED
Scanning Side	Simplex/Duplex
Scanning Modes	Black and White, Error Diffusion, 256-level Grayscale, Advanced Text Enhancement, Advanced Text Enhancement II, 24-bit Color
Scanning Resolution (Primary Scan Lines x Secondary Scan Lines)	100 x 100dpi/150 x 150dpi/200 x 200dpi/ 240 x 240dpi/300 x 300dpi/400 x 400dpi/ 600 x 600dpi
Scanning Speed (Conditions: Pentium 4 3.2 GHz CPU, 1 GB memory, LTR/A4 document size)	
Black and White Simplex	200 x 200 dpi 25 pages/min.(DR-2510C), 20 pages/min.(DR-2010C)
	300 x 300 dpi 25 pages/min.(DR-2510C), 20 pages/min.(DR-2010C)
Duplex	200 x 200 dpi 50 images/min.(DR-2510C), 40 images/min.(DR-2010C)

	300 x 300 dpi	50 images/min.(DR-2510C), 40 images/min.(DR-2010C)
Grayscale Simplex	200 x 200 dpi	25 pages/min.(DR-2510C), 20 pages/min.(DR-2010C)
	300 x 300 dpi	25 pages/min.(DR-2510C), 20 pages/min.(DR-2010C)
Duplex	200 x 200 dpi	50 images/min.(DR-2510C), 40 images/min.(DR-2010C)
	300 x 300 dpi	50 images/min.(DR-2510C), 40 images/min.(DR-2010C)
24-bit Color Simplex	100 x 100 dpi	25 pages/min.(DR-2510C), 20 pages/min.(DR-2010C)
	200 x 200 dpi	25 pages/min.(DR-2510C), 20 pages/min.(DR-2010C)
Duplex	100 x 100 dpi	50 images/min.(DR-2510C), 40 images/min.(DR-2010C)
	200 x 200 dpi	50 images/min.(DR-2510C), 40 images/min.(DR-2010C)
Interface	Hi-Speed USB 2.0	
Other Functions	Auto document thickness adjustment, folio scanning	
External Dimensions	11.7" x 6.3" x 6.3" (W x D x H) 298mm x 160mm x 160mm (W x D x H)	
Maximum External Dimensions (with Document Feed Tray and Eject Tray Open)	11.7" x 19.5" x 9.8" (W x D x H) 298mm x 490mm x 245mm (W x D x H)	
Weight (without AC adapter)	Approximately 5.3 lb (2.4 kg).	
Power Supply (using AC adapter)	DC 16 V, 1.0 A	
Power Consumption	Scanning: Maximum 16 W In the Sleep mode: Maximum 2.2 W With power switch OFF: Maximum 0.5 W	
Noise	Not more than 66 dB	
Operating Environment	Temperature: 10°C to 32.5°C (50°F to 90.5°F) Humidity: 20% to 80% RH	

AC Adapter (100 to 240 V type)

Model Number	MG1-3607
Input	AC 100 to 240 V, 50/60 Hz, 65 VA to 82 VA
Output	DC 16 V, 1.8 A
Power Consumption	Under 0.5 W (AC adapter only)
Weight	Approximately 0.3 kg (including power cord)

Replacement Parts

Exchange roller kit (product code: 2445B001)

Kit to replace the rollers (retard roller, feeding roller) and document holding guide.

- For information on replacing the rollers, see "Removing/Attaching the Feeding Roller," on p. 65. and "Removing/Attaching the Retard Roller," on p. 67.
- For information on replacing the document holding guide, see "Removing/Attaching the Document Holding Guide," on p. 69.
- Contact your local authorized Canon dealer or service representative for detailed information about the replacement parts.

Product specifications are subject to change without notice.

External Dimensions

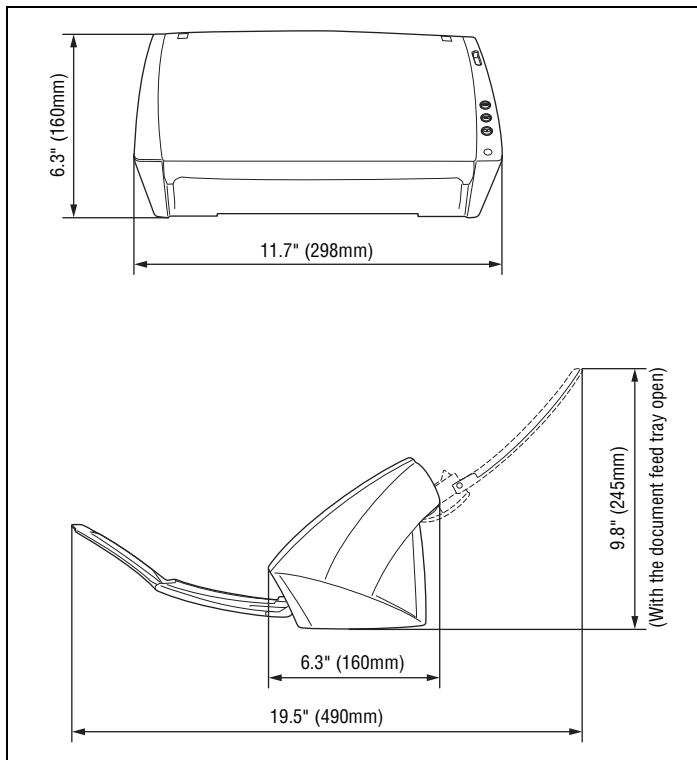

FCC REGULATIONS (For 120 V model)

Document Scanner, Model M11065/M11064

This device complies with Part 15 of the FCC Rules. Operation is subject to the following two conditions: (1)

This device may not cause harmful interference, and (2) this device must accept any interference received, including interference that may cause undesired operation.

Note: This equipment has been tested and found to comply with the limits for a Class B digital device, pursuant to Part 15 of the FCC Rules. These limits are designed to provide reasonable protection against harmful interference in a residential installation. This equipment generates, uses, and can radiate radio frequency energy and, if not installed and used in accordance with the instructions, may cause harmful interference to radio communications. However, there is no guarantee that interference will not occur in a particular installation. If this equipment does cause harmful interference to radio or television reception, which can be determined by turning the equipment OFF and ON, the user is encouraged to try to correct the interference by one or more of the following measures:

- Reorient or relocate the receiving antenna.
- Increase the separation between the equipment and receiver.
- Connect the equipment into an outlet on a circuit different from that to which the receiver is connected.
- Consult the dealer or an experienced radio/TV technician for help.

Use of shielded cable is required to comply with class B limits in Subpart B of Part 15 of FCC Rules.

Do not make any changes or modifications to the equipment unless otherwise specified in the manual. If such changes or modifications should be made, you could be required to stop operation of the equipment.

Canon U.S.A. Inc.

One Canon Plaza, Lake Success NY 11042, U.S.A.

Tel. No. (516)328-5000

RADIO INTERFERENCE REGULATIONS (For 120 V models)

This digital apparatus does not exceed the Class B limits for radio noise emissions from digital apparatus as set out in the Interference-causing equipment standard entitled "Digital Apparatus", ICES-003 of the Industry Canada.

RÈGLEMENT SUR LE BROUILLAGE RADIOÉLECTRIQUE (For 120 V models)

Cet appareil numérique respecte les limites de bruits radioélectriques applicables aux appareils numériques de Classe B prescrites dans la norme sur le matériel brouilleur: "Appareils Numériques", NMB-003 édictée par l'Industrie Canada.

European Union (and EEA) only.



This symbol indicates that this product is not to be disposed of with your household waste, according to the WEEE Directive (2002/96/EC) and your national law. This product should be handed over to a designated collection point, e.g., on an authorized one-for-one basis when you buy a new similar product or to an authorized collection site for recycling waste electrical and electronic

equipment (EEE). Improper handling of this type of waste could have a possible negative impact on the environment and human health due to potentially hazardous substances that are generally associated with EEE. At the same time, your cooperation in the correct disposal of this product will contribute to the effective usage of natural resources. For more information about where you can drop off your waste equipment for recycling, please contact your local city office, waste authority, approved WEEE scheme or your household waste disposal service. For more information regarding return and recycling of WEEE products, please visit www.canon-europe.com.

(EEA: Norway, Iceland and Liechtenstein)

MODEL NAMES

Model DR-2010C is identical to model M11065.

Model DR-2010C is the sales name of model M11065.

Model DR-2510C is identical to model M11064.

Model DR-2510C is the sales name of model M11064.

INDEX

A

AC Adapter 6

B

Batch Separation 52

Bypass mode 23

C

CapturePerfect 3.0 12, 25

Cards, placing 23

Cleaning

Document holding guide 64

Main body 62

Rollers 63

Sensor glass 63

Connecting to the Computer 15

Counter, resetting 70

D

Dimensions 79

Disposal 8

Document eject area 10

Document feed tray 10

Document feeder 10

Document guides 10

Document holding guide

Attaching 69

Removing 69

Documents 18

Placing 21

Double feed detection 51

Driver 12

E

Extension tray 10

F

Features 8

Feed Selection lever 10

Feeding roller

Attaching 66

Removing 65

Folded documents, placing 24

Front unit 10

H

Handling 7

I

Installation location 5

Introduction 3

ISIS/TWAIN Driver Properties Dialog Box 38

Auto color detection 40

Background, removing 49

Breed through, preventing 49

Brightness, adjusting 46

Contrast, adjusting 46

Deskewing 43

Double feed detection 51

Feeding options 52

Gamma curve settings 47

Image contour, adjusting 48

Moire, reducing 44

Omitting a special color 50

Paper size settings 41

Prescan 53

Recovering from the error 51

Red color, enhancing 50

Registering scan Conditions 54

Resolution, setting 42

Rotating image 48

Scan area, adjusting 44

Scan mode setting 39

Scanning side settings 42

Text orientation, correcting 49

Version, checking 54

J

Job buttons 10

Job function 27

Job Registration Tool 55

K

Kensington 10

L			
Load limit mark	21		
Long Document mode	35		
M			
Maintenance	62		
Moving the scanner	6		
N			
Name of parts	10		
O			
OPEN button	10		
Operating system	11		
P			
Page Separation mode	21		
Paper jam, clearing	33		
Power connector	10		
Power indicator	10		
Power switch	10		
Practical examples	32		
Preparing the scanner	20		
Document eject tray	20		
Document feed tray	20		
Document stopper	20		
R			
Recognizing the scanner by computer	16		
Replacement parts	78		
Retard roller			
Attaching	68		
Removing	67		
Roller, replacing			
Counter, resetting	70		
Replacement cycle	65		
S			
Scan Panel	28		
Scanning methods	25		
Service	72		
Setup disc	12		
Custom Installation	12		
Read Manuals	12		
		Typical Installation	12
		Software	
		Installing	12
		Uninstalling	75
		Special scanning	
		11" X 17"/A3 (single-sided)	30
		B&W and color pages mixed	29
		Background, removing	31
		Bleed through, reducing	31
		Deleting the lines of a specified color	31
		Different sized documents	30
		Enhancing the Red Color	31
		Enhancing the text	29
		File size, reducing	32
		Moire, reducing	31
		Saving text data for keyword search	32
		Security setting for PDF	32
		Skipping blank pages	30
		Text orientation, correcting	31
		Specifications	77
		System requirements	11
		T	
		Troubleshooting	72
		Typical Installation	13
		U	
		USB connector	10
		USB Link switch	8